

PRESSURE SENSOR

CZ-100P Resin Pressure Sensor



RoHS 指令対応

As one of quality control method for products made by extrusion molding is a method of unifying the resin extruding pressure. The resin sensor (CZ-100P) is used to detect the resin extruding pressure.

CZ-100P



Resin Pressure Sensor
 [G] RoHS Compliant

PG500



Resin Pressure Indicator
 [G] RoHS Compliant

HA930



Resin Pressure Controller
 [G] RoHS Compliant

PCT-300



Output Converter for Resin Pressure Sensor
 [G] RoHS Compliant

■ Features

CZ-100P

The CZ-100P pressure sensor is a push rod lead-type sensor and thus there is no concern of resin contamination, even if a diaphragm rupture occurs.

Resin Pressure Sensor

PG500

Easy-to-read large LED
 100msec sampling cycle time
 Optional communication (RS422A/RS-485), retransmission output, up to two alarms

Resin Pressure Indicator

HA930

Strain gauge input type
 Ultra High Speed Sampling 0.025 sec
 7 inputs and 5 outputs
 Two Channels in One Controller

Resin Pressure Controller

PCT-300

Signal converter for CZ-100P
 Up to four analog outputs
 Linearization function

Output Converter for Resin Pressure Sensor

■ Applications

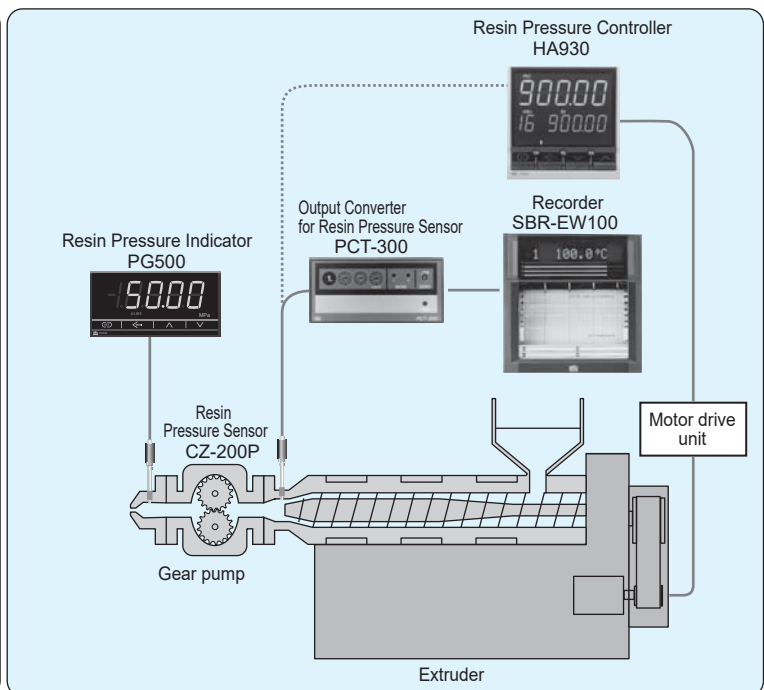
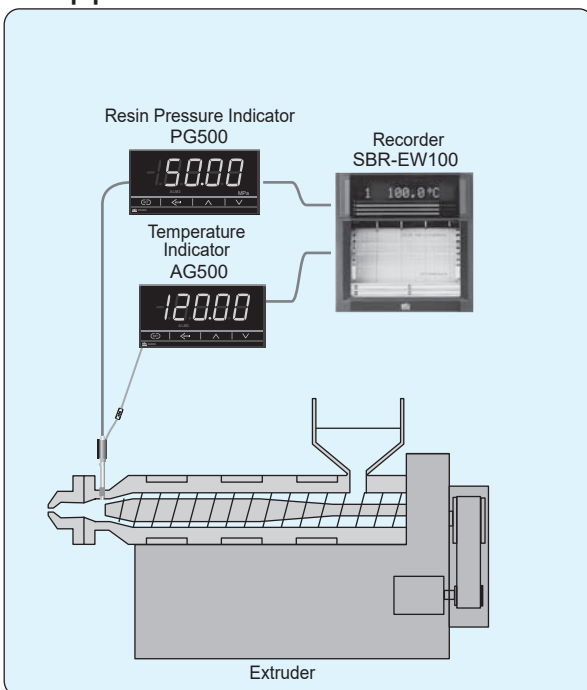

● Name of Parts (CZ-100P-H type)

Diaphragm

Pressure port of CZ-100P resin pressure sensor.
In addition to the SUS630, Hastelloy C and ceramic kanigen plating are available.

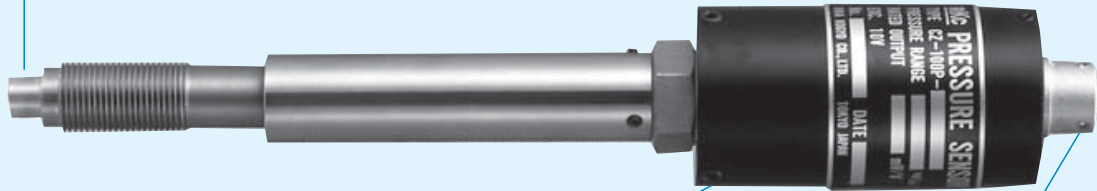

Diaphragm material and surface treatment

SUS630 (Standard)
High-strength stainless steel is used standard.

Hastelloy C
Ideal when using corrosive resin.

Ceramic kanigen plating
Plating that increases abrasion resistance.

Outer tube

The outer tube has a completely sealed double-layer structure that minimizes the effects of external temperature changes.

Connector

Connector for the converter. A water-proof connector type and water-proof direct-connection cable type are also available.

● Specifications

Construction	: 4 sides adhered strain gauge type wheatstone bridge
Rated Pressure	: Fixed Nut type 20MPa, 35MPa, 50MPa, 70MPa, 100MPa
	: Loose Nut type (LL type) 5MPa, 10MPa
	: Loose Nut type (HL type) 20MPa, 35MPa, 50MPa, 70MPa, 100MPa
	: Loose Nut type (LLA type) 0.5MPa, 1MPa
	: LLA type 1MPa : 1.0 to 1.6mV/V, LLA type 0.5MPa : 0.5 to 0.8mV/V
Rated Output	: 1.0 to 1.8mV/V [At 150°C of diaphragm temperature]
Bridge Impressed Voltage	: 10V DC (at PCT-300, CT-300), 7.7V DC (at PG500, REX-PG410)
Accuracy	: SUS630 type (At At 150°C of diaphragm temperature)
	: Within ±1% of full scale Within ±2% of full scale (Over 70 MPa)
Linearity	: HASTELLOY C type Contact to RKC
	: SUS630 type (At At 150°C of diaphragm temperature)
	: Within ±1% of full scale Within ±2% of full scale (Over 70 MPa) HASTELLOY C type Contact to RKC
Hysteresis	: SUS630 type
	: Within ±0.5% of full scale Within ±1% of full scale (Over 50 MPa) Within ±2% of full scale (Over 70 MPa)
	: Within ±0.2% of full scale (1MPa type)
	: HASTELLOY C type Contact to RKC
Reproducibility	: Within ±0.2% of span • More than 480°C of 10,20MPa : Within ±2% of full scale
Zero Balance	: ±0.6mV/V (Within ±40% of span)
Bridge Resistance	: 374Ω±5Ω (Input resistance),
	: 350Ω±5Ω (Output resistance)

● Temperature characteristics

Maximum Temperature of the Diaphragm	: 400°C
Maximum Temperature of the Strain Gauge	: 150°C
Zero Point Temperature Effect	: SUS630 type ±0.2%/10°C
	: ±0.4%/10°C (0.5MPa)
	: HASTELLOY C type : Contact to RKC

* When the temperature at the bottom of outer tube (nut side) is more than 134°C, the temperature at the strain gauge exceed 150°C.
If the temperature at the strain gauge exceed 150°C, the performance cannot be assured.

Therefore, cover the heat source with a heat insulating material so that the above temperature does not exceed 150°C.

The temperature at the strain gauge can be expected not to rise when:

- the long type of sensor is used or
 - the sensor is installed a slant or transversely.
- If any of the above measures can be taken, take it.

● Mechanical characteristics

Allowable Overload	: Within 120% of span (Within 500% of 1MPa type, Within 1000% of 0.5MPa type)
Marginal Overload	: Within 150% of span (Within 1000% of 1MPa type, Within 2000% of 0.5MPa type)
Recommended tightening torque	: Fixed nut type: 30 N•m (300 kgf•cm)
	: Loose nut type: 60 N•m (600 kgf•cm)

CZ-100P

Resin Pressure Sensor

External Dimensions and Mounting Hole

For fixed nut type **CZ-100P-HB** / **CZ-100P-HC** Measuring Range : 0 to 20, 0 to 35, 0 to 50, 0 to 70, 0 to 100MPa

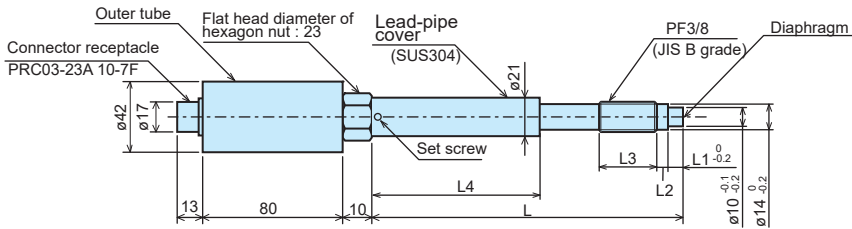

Mounting hole (Unit : mm)

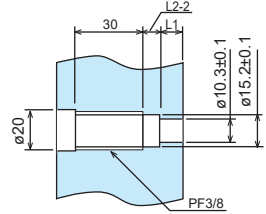

Standard dimensions and weight

	L	L1	L2	L3	L4	Weight
HB	150	8	4	30	90	Approx.650g
HC	180	8	4	30	120	Approx.700g

• Element finished to JIS B grade.
Install the sensor so that each screw is smoothly inserted.

For loose nut type **CZ-100P-HL** / **CZ-100P-LL** Measuring Range : 0 to 20, 0 to 35, 0 to 50, 0 to 70, 0 to 100MPa
Measuring Range : 0 to 5, 0 to 10MPa

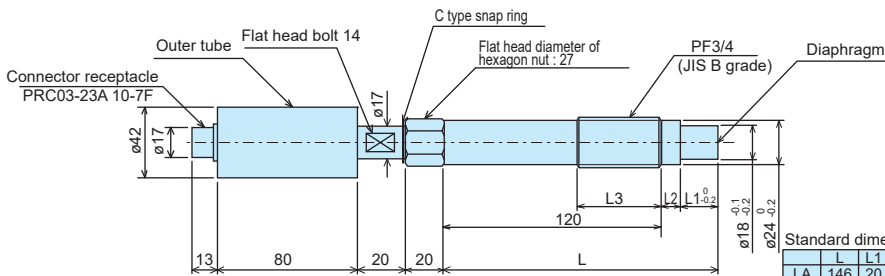

Mounting hole (Unit : mm)

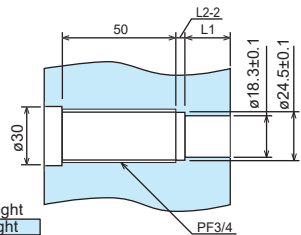

Standard dimensions and weight

	L	L1	L2	L3	Weight
LA	146	20	6	45	Approx.0.9kg
LB	195	20	55	45	Approx.1.0kg
LC	250	20	110	45	Approx.1.2kg

• Element finished to JIS B grade.
Install the sensor so that each screw is smoothly inserted.

For fixed nut type **CZ-100P-HZ** (YICZ100P24) Measuring Range : 0 to 20, 0 to 35, 0 to 50, 0 to 70, 0 to 100MPa

Order drawing No YICZ100P24

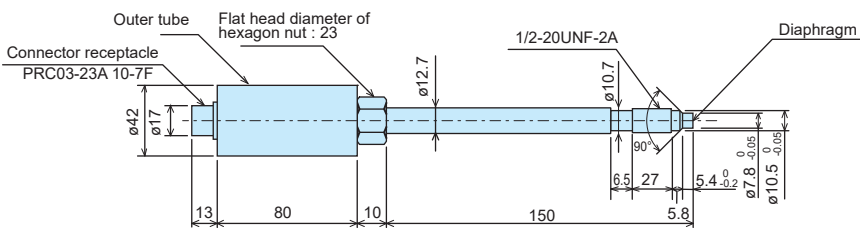

Mounting hole (Unit : mm)

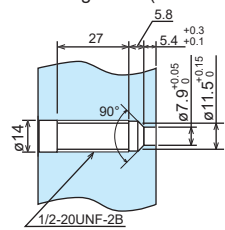

• Element finished to JIS B grade.
Install the sensor so that each screw is smoothly inserted.

For loose nut type **CZ-100P-LLA** Low pressure type Measuring Range : 0 to 0.5, 0 to 1MPa

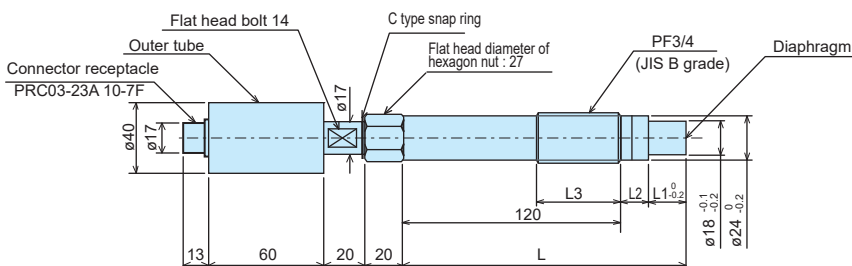

Mounting hole (Unit : mm)

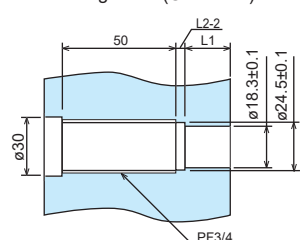

Standard dimensions and weight

	L	L1	L2	L3	Weight
LLA	146	20	6	45	Approx.0.9kg

• Element finished to JIS B grade.
Install the sensor so that each screw is smoothly inserted.

PG500

Resin Pressure Indicator



CE Marking
UL, cUL
C-Tick



Specifications

Input

Input type	: Strain gauge type pressure sensor a) Pressure sensor gain setting range : 0.500 to 1.999mV/V -6.0mV to 15.9mV (Including zero point adjustment range) b) Pressure sensor gain setting range : 1.000 to 1.999mV/V -9.8mV to 25.9mV (Including zero point adjustment range) c) Pressure sensor gain setting range : 2.000 to 2.999mV/V -12.3mV to 32.6mV (Including zero point adjustment range) d) Pressure sensor gain setting range : 3.000 to 4.000mV/V -16.1mV to 42.5mV (Including zero point adjustment range)
Gain setting	: a) Gain setting decimal point position: Three decimal place, Four decimal place b) Setting range: 0.500 to 4.000mV/V (Three decimal place) 0.5000 to 1.9999mV/V (Four decimal place)
Shunt resistance	: 40.0 to 100.0% (Functions when a resistance for sensitivity adjustment built-in pressure sensor is used)
Input impedance	: More than 1MΩ
Input break action	: Up-scale/Down-scale (Selectable)
Sensor power supply	: 7.7V DC±3% (Within 30mA DC)
Sampling time	: 0.1 sec
Input adjustment	: a) Zero point adjustment 1. Manual setting : -Input span to +Input span 2. Auto-zero function : -5.0 to +5.0mV (Input conversion) b) Ratio setting 1. Manual setting (Gain adjustment setting) : 0.500 to 1.500 2. Automatic calibration function Auto calibration is used to automatically set the PV ratio so that the measured value (PV) will be the pressure of the shunt resistance output value. (Functions when a resistance for sensitivity adjustment built-in pressure sensor is used) c) Linearize : Use to correct the non-linear nature of pressure sensor CZ-100P/CZ-200P. • Select the linearizing type symbol engraved on the rated nameplate attached to the CZ-100P or CZ-200P housing. d) Digital filter : 0.0 to 100.0 sec (OFF when 0 is set.)

Performance

Input accuracy	: ±0.1% of Input span
Influence of ambient temperature	: a) Input : ±0.006% of Input span/°C b) Sensor power supply : ±0.013% of Output span/°C

Display

Display digit	: 5-digits (The most significant digit : -1 or 1)
---------------	---

Hold function

Peak hold	Highest measured value is held
Bottom hold	Lowest measured value is held • The held values are reset manually, by external contact signal or by communication after the confirmation by the operator. • Data is not backed up when the instrument power supply is off.

Digital input (Contact input)

Number of inputs	: 3 points (DI1 and DI2)
Input method	: Non-voltage contact input (OPEN : 500kΩ or more, CLOSE : 10Ω or less)
Function	: DI1 : Auto-zero DI2 : Hold reset, DI3 : Alarm interlock reset

Alarm (Optional)

Number of alarms	: Up to 4 points
Alarm type	: Process High, Process low (Available for hold function)
Alarm output	: Relay output, Form A contact, 250V AC 0.5A (resistive load)
Other functions	: a) Energized/de-energized action is configurable. b) Delay timer : 0.0 to 600.0 sec c) Interlock (latch) function is configurable.

Communication (Optional)

Communication method	: RS-485 (2-wire), RS-422A (4-wire) a) ANSI X3.28 sub-category 2.5A4 (RKC standard) b) MODBUS-RTU • Selectable
Maximum connection	: 31 units

Analog Retransmission Output (Optional)

Output signal	: 0 to 1V DC, 0 to 5V DC, 1 to 5V DC, 0 to 10V DC Load resistance : More than 1kΩ Output impedance : Less than 0.1Ω
	: 0 to 10mV DC, 0 to 100mV DC Load resistance : More than 20kΩ Output impedance : Less than 10Ω
	: 4 to 20mA DC, 0 to 20mA DC Load resistance : Less than 600Ω Output impedance : More than 1MΩ
Output type	: Measured value (PV)
Output accuracy	: ±0.1% of span
Output resolution	: More than 12 bits

General Specifications

Waterproof/Dustproof	: NEMA4X, IP66 • Waterproof/Dustproof protection only effective from the front in panel mounted installation.
Supply voltage	: a) 90 to 264V AC (50/60Hz, Selectable) Rating : 100 to 240V AC b) 21.6 to 26.4V AC ±10% (50/60Hz, Selectable) Rating : 24V AC c) 21.6 to 26.4V DC Rating : 24V DC
Power consumption	: a) 100 to 240V AC : Less than 10VA (at 240VAC) b) 24V AC : Less than 7.0VA c) 24V DC : Less than 210mA
Rush current	: Less than 12A
Memory backup	: Backed up by non-volatile memory (FRAM) • Data retaining period : Approx. 10 years • Number of writing : Approx. 10,000,000,000 times. (Depending on storage and operating conditions.)
Insulation resistance	: More than 20MΩ (500V DC) between measured terminals and ground More than 20MΩ (500V DC) between power terminals and ground
Dielectric voltage	: 1500V AC for one minute between measured terminals and ground 1500V AC for one minute between power terminals and ground
Weight	: Approx. 200g
Ambient temperature	: -10 to +50°C (14 to 122°F)
Ambient humidity	: 5 to 95% RH (Non condensing)
Ambient atmosphere	: Free from corrosive and flammable gas and dust. Free from external noise, vibration, shock, and exposure to direct sunlight.

External Dimensions

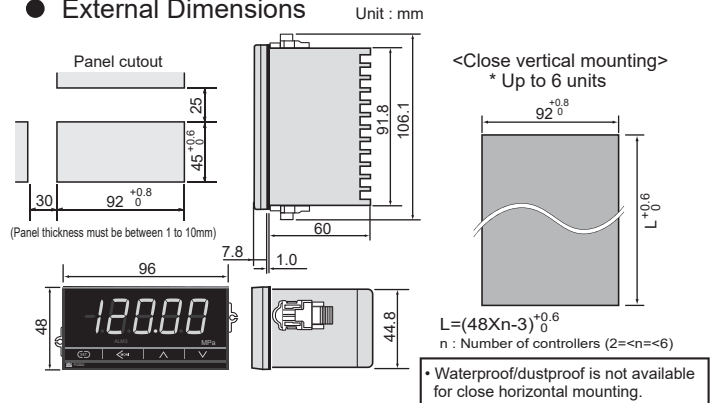

Model and Suffix Code

No.	Specifications	Model and Suffix Code	Hardware coding only Quick start code																	
			①	②	③	④	⑤	⑥	⑦	⑧	⑨	⑩								
		PG500			*															
①	Input type	Standard type Intrinsic safety type Standard type (Loose Nut : 0.0 to 0.5MPa, Fixed Nut : 0 to 5MPa) Intrinsic safety type (Loose Nut : 0.0 to 0.5MPa, Fixed Nut : 0 to 5MPa) For 3.33mV/V output type	A	B	C	D	X													
②	Power supply	100 to 240V AC 24V AC/DC	4	3																
③	Alarm	Not supplied Number of alarm output (Specify 1 to 4)	N																	
④	Analog output	Not supplied See Analog Output Signal Code Table, Code : 1 to 8)	N																	
⑤	Communication	Not supplied RS-422A RS-485	N	4	5															
⑥	Initial setting	No quick start code (Default setting) Specify quick start code	N	1																
⑦	Alarm 1	See Alarm Code Table																		
⑧	Alarm 2	See Alarm Code Table																		
⑨	Alarm 3	See Alarm Code Table																		
⑩	Alarm 4	See Alarm Code Table																		

Analog Output Signal Code Table

1	0 - 10mV DC	7	0 - 20mA DC
2	0 - 100mV DC	8	4 - 20mA DC
3	0 - 1V DC		
4	0 - 5V DC		
5	0 - 10V DC		
6	1 - 5V DC		

Alarm Code Table

N	No alarm
H	Process High
J	Process Low
K	Process High with Alarm Hold
L	Process Low with Alarm Hold

Rear Terminals

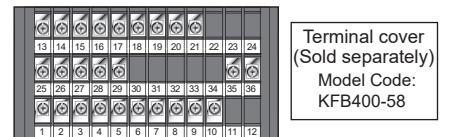

• Use a solderless terminal for screw size M3X6.

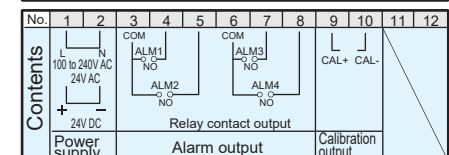
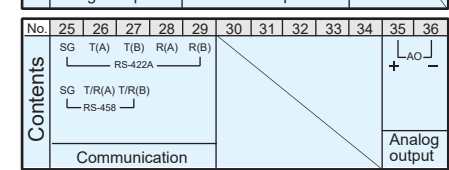
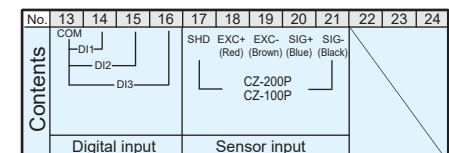

PCT-300

Output Converter for Resin Pressure Sensor



Green RoHS Compliant

Specifications

Input

Input type : RKC's resin pressure sensor GZ-200P (CZ-100P)
 Input range : a) Standard type : 0 to 19.99mV
 b) Safe explosion proof type : 0 to 11.6mV
 • Excepting zero point adjustment range
 Input impedance : More than 1MΩ
 Input break action : Up scale(The sensor power supply break is the same)

Sensor Power Supply

Applied voltage : a) Standard type : 10V DC
 b) Safe explosion proof type : 8.2V DC
 Accuracy : +0.1 to -0.4%
 Temperature drift : Less than 30ppm/°C

Zero point

Adjustment range : a) Standard type : ±7mV (Input conversion)
 b) Safe explosion proof type : ±6mV (Input conversion)
 Temperature drift : ±0.02%/°C of span

Gain

Setting range : a) Standard type : 10.00 to 19.99mV can be used as rating (10V etc.)
 b) Safe explosion proof type : 5.08 to 11.60mV can be used as rating (10V etc.)
 Setting accuracy : ±0.2%/°C of span
 Temperature drift : Less than ±100ppm/°C
 Optional function : Gain selector switch (Selection 1x/2x)

Output

Output signal : 0 to 10V DC (Load resistance : More than 2kΩ)
 0 to 10mV DC (Load resistance : More than 10kΩ)
 1 to 5V DC (Load resistance : More than 1kΩ)
 4 to 20mA DC (Load resistance : Less than 600Ω)
 Monitor voltage : 0 to 10V DC (Pin size of tester confirming: 2.0)

General Specifications

Linearity : ±0.01% of span
 Noise : 0.1%p-p of span (0.1 to 10Hz)
 Response : 10Hz/100Hz selectable (Factory shipment : 10Hz)
 Power supply : 90 to 264V AC (Including supply voltage variation)
 [Rating : 100 to 240V AC] (50/60Hz common use)
 Power consumption : 100 to 240V AC : Less than 7.5VA (at 100V)
 Less than 12.5VA (at 240V)

Insulation resistance : More than 100MΩ (500V DC) between input/output terminals and power terminals
 More than 100MΩ (500V DC) between input/output terminals and ground
 More than 100MΩ (500V DC) between power terminals and ground
 Dielectric voltage : 2300V AC for one minute between input/output terminals and power terminals
 2300V AC for one minute between input/output terminals and ground
 2300V AC for one minute between power terminals and ground
 Weight : Approx 290g

Operating Environments

Ambient temperature : 0 to +50°C (32 to 122°F)
 Ambient humidity : 45 to 85% RH (Non condensing)
 Ambient atmosphere : Free from corrosive and flammable gas and dust.
 Free from external noise, vibration, shock, and exposure to direct sunlight.

Rear Terminals

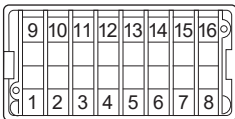

No.	9	10	11	12	13	14	15	16
Contents				SHD EXC+ EXC- SIG+ SIG- (Red) (Brown) (Blue) (Black)				
	Analog output			Sensor input				
	* Color : Wire color of cable for pressure sensor							
No.	1	2	3	4	5	6	7	8
Contents								
	Ground		Power supply	Analog output				

External Dimensions

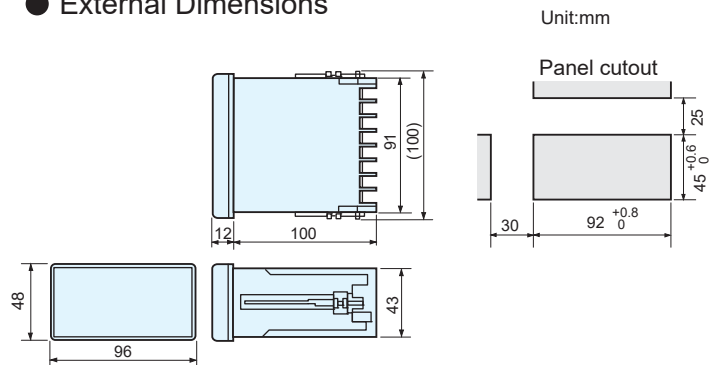

Model Code

Specifications	Model and Suffix Code			
	PCT-300			
Type	Standard type			
	Intrinsically safe explosion proof construction pass type	N	E	
Number of output	2 outputs (0 to 10V DC, 0 to 100mV DC)		2	
	3 outputs (0 to 10V DC, 0 to 100mV DC, 1 to 5V DC)		3	
	4 outputs (0 to 10V DC, 0 to 100mV DC, 1 to 5V DC, 4 to 20mA DC)		4	
Option	Not supplied			N
	Gain change switch (x1 or x2)			G
	Linearization function			L

Power supply voltage | 100 to 240V DC

HA930

Resin Pressure Digital Controller
 (Strain Gauge Input Type)



High-resolution inputs with a sampling cycle of 0.025 seconds and PID constants that can be set in increments of 0.01 seconds enable this controller to control process quantities that change rapidly. A strain gauge type pressure sensor can be directly connected.

Intrinsic Safety

Intrinsically Safe Explosion proof Construction Resin Pressure Meter (For Indoor, outdoor)

The qualification No. of the intrinsically safe explosion proof construction resin pressure meter obtained from the ministry of Labor, Japan, is T55821 (For indoor use) T56658 (For outdoor use). The explosion class and ignition group of the objective gases and steam are i2G3. The qualified consists of the pressure sensor CZ-100P and safety barrier (RZB-001), but the output converter is not subject to qualification testing as a general sending/receiving instrument. For indoor use, the standard connector or the waterproof connector can be selected. For outdoor use, the waterproof connector must be used.

● Sensor Specifications

Construction	: 4 sides adhered strain gauge type wheatstone bridge
Rated Pressure	: Fixed Nut type 20MPa, 35MPa, 50MPa, 70MPa, 100MPa Loose Nut type (LL type) 5MPa, 10MPa Loose Nut type (HL type) 20MPa, 35MPa, 50MPa, 70MPa, 100MPa Loose Nut type (LLA type) 0.5MPa, 1MPa
Rated Output	: 1.0 to 1.8mV/V [At 150°C of diaphragm temperature] (LLA type 1MPa : 1.0 to 1.6mV/V, LLA type 0.5MPa : 0.5 to 0.8mV/V)
Bridge Impressed Voltage	: 10V DC (at PCT-300, CT-300), 7.7V DC (at PG500, REX-PG410)
Accuracy	: SUS630 type (At At 150°C of diaphragm temperature) Within ±1% of full scale Within ±2% of full scale (Over 70 MPa) HASTELLOY C type Contact to RKC
Linearity	: SUS630 type (At At 150°C of diaphragm temperature) Within ±1% of full scale Within ±2% of full scale (Over 70 MPa) HASTELLOY C type Contact to RKC
Hysteresis	: SUS630 type Within ±0.5% of full scale Within ±1% of full scale (Over 50 MPa) Within ±2% of full scale (Over 70 MPa) Within ±0.2% of full scale (1MPa type) HASTELLOY C type Contact to RKC
Reproducibility	: Within ±0.2% of span • More than 480°C of 10,20MPa : Within ±2% of full scale
Zero Balance	: ±0.6mV/V (Within ±40% of span)
Bridge Resistance	: 374Ω±5Ω (Input resistance), 350Ω±5Ω (Output resistance)

● Temperature characteristics

Maximum Temperature of the Diaphragm	: 400°C
Maximum Temperature of the Strain Gauge	: 150°C
Zero Point Temperature Effect	: SUS630 type ±0.2%/10°C ±0.4%/10°C (0.5MPa) HASTELLOY C type : Contact to RKC

* When the temperature at the bottom of outer tube (nut side) is more than 134°C, the temperature at the strain gauge exceed 150°C. If the temperature at the strain gauge exceed 150°C, the performance cannot be assured. Therefore, cover the heat source with a heat insulating material so that the above temperature does not exceed 150°C.
The temperature at the strain gauge can be expected not to rise when:
• the long type of sensor is used or
• the sensor is installed a slant or transversely.
If any of the above measures can be taken, take it.

● Mechanical characteristics

Allowable Overload	: Within 120% of span (Within 500% of 1MPa type, Within 1000% of 0.5MPa type)
Marginal Overload	: Within 150% of span (Within 1000% of 1MPa type, Within 2000% of 0.5MPa type)
Recommended tightening torque	: Fixed nut type: 30 N·m (300 kgf·cm) Loose nut type: 60 N·m (600 kgf·cm)

● Safety Barrier Specifications

Explosion proof construction	: Intrinsically safe explosion proof construction (i2G3)
Use rated	: Power supply circuit 9V 50mA, Signal circuit 6V 50mA, Thermocouple circuit 6V 50mA
Rating for maintaining safety	: 250V AC, 50/60Hz, 250V DC : Wiring between the resin pressure sensor and safety barrier : 0.6 mH or less
Allowable inductance	: Wiring between the resin pressure sensor and safety barrier : 0.1μF or less
Allowable capacitance	: -10 to +40°C (14 to 104°F)
Ambient temperature	: 45 to 85% RH (Non condensing)
Ambient humidity	: Iron (Coating)
Cover	: Brass (Nickel plating)
Bus bar	: Ground this safety barrier so that its grounding resistance will be less than the grounding reference resistance value of shunt diode type safety barriers (e.g. less than 1Ω) conforming to each national standard. (Requirements) : Approx. 850g
Ground requirement	
Weight	

● Terminal Configuration

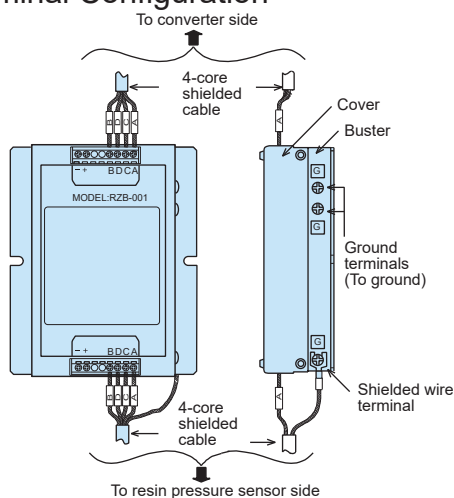

● External Dimensions

Unit:mm

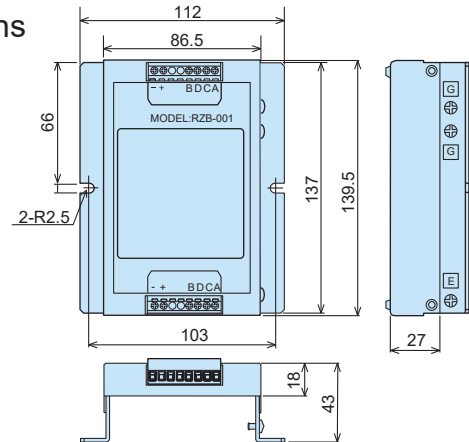

● External Wiring

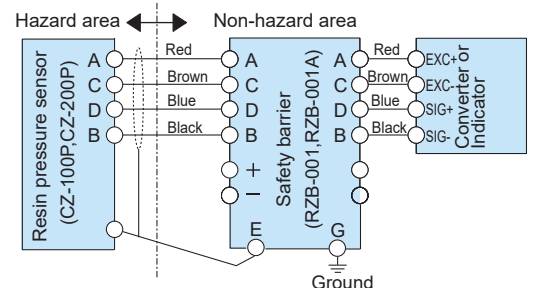

● Model Code

Specification	Model Code
Intrinsic Safety (For indoor)	RZB-001A1
Intrinsic Safety (For outdoor)	RZB-001A2

Specification	Model Code
Intrinsically safe circuit side (Hazard area) CZ-100P ↔ RZB-001 (5m)	W-AB-Y \square -PB-5000
Non-intrinsically safe circuit side (Non hazard area) RZB-001 ↔ AG500 (1m) or PCT-300(1m)	W-AB-N \square -BA-1000

* This product has passed the qualification test of intrinsically safe explosion proof when combined with our resin pressure sensor (CZ-100P/CZ-200P). Always combine and use this product with our resin pressure sensor.

Model and Suffix Code

Specifications	Model and Suffix Code			
	CZ-100P - <input type="checkbox"/> - <input type="checkbox"/> <input type="checkbox"/> <input type="checkbox"/>			
Screw type	Standard Type Fixed nut type PF3/8 Tip diameter : 10mm, Under nut : L=150mm PF3/8 Tip diameter : 10mm, Under nut : L=180mm 1/2-20UNF Tip diameter : 7.8mm, Under nut : L=150mm *1 Nonstandard size	HB		
	Loose nut type (0 to 20, 0 to 35, 0 to 50, 0 to 70, 0 to 100MPa) PF3/4 Tip diameter : 18mm, Under nut : L=146mm, L2=6mm Nonstandard size Loose nut type (0 to 5, 0 to 10MPa) PF3/4 Tip diameter : 18mm, Under nut : L=146mm, L2=6mm Nonstandard size	HL HLZ		
	Low pressure type (0 to 1MPa) Loose nut type (0 to 20, 0 to 35, 0 to 50, 0 to 70, 0 to 100MPa) PF3/4 Tip diameter : 18mm, Under nut : L=146mm, L2=6mm	LL LLZ		
Diaphragm material	SUS630 (Standard) Hastelloy C		S H	
Diaphragm surface treatment	Standard Ceramic kanigen plating			N K
Intrinsically safe	Non-intrinsic safety (Standard) Intrinsic safety (For indoor use) Intrinsic safety (For outdoor use)			No symbol G H

*1 Please specify Drawing No.YICZ100P24

• Please specify pressure range.

Pressure Range Code Table

Specifications	Range
Fixed nut type	0 to 20MPa, 0 to 35MPa, 0 to 50MPa, 0 to 70MPa, 0 to 100MPa
Loose nut type	CZ-100P-HL 0 to 20MPa, 0 to 35MPa, 0 to 50MPa, 0 to 70MPa, 0 to 100MPa
	CZ-100P-LL 0 to 5MPa, 0 to 10MPa
	CZ-100P-LLA 0 to 1MPa

Cable

· For cables with specifications other than those below, please contact RKC agent.

Standard Type	Specifications		
	CZ-100P ←→	PG500 (Length : 5m) : Y-shaped terminal lugs (M3) PCT-300 (Length : 5m) : Y-shaped terminal lugs (M3)	Heat-resistant glass coated cable Silicon coated cable
CZ-100P ←→	CT-300 (Length : 5m) : Plug	Heat-resistant glass coated cable Silicon coated cable	W - AB - N <input type="checkbox"/> - PP - 5000 W - AB - N <input type="checkbox"/> - PP - 5000

The letter in the indicates the cable coating type. Select from the three types below.

G: Heat-resistant glass coated cable, V: Vinyl coated cable, S :Silicon coated cable

 <ul style="list-style-type: none"> • Before operating this product, read the instruction manual carefully to avoid incorrect operation. • This product is intended for use with industrial machines, test and measuring equipment. It is not designed for use with medical equipment. • If it is possible that an accident may occur as a result of the failure of the product or some other abnormality, an appropriate independent protection device must be installed. 	Caution for the export trade
	All transactions must comply with laws, regulations, and treaties.
	Caution for imitated products
	As products imitating our product now appear on the market, be careful that you don't purchase these imitated products. We will not warrant such products nor bear the responsibility for any damage and/or accident caused by their use.

RKC® **RKC INSTRUMENT INC.**
(RIKA KOGYO CO.,LTD)

HEAD OFFICE : 16-6, KUGAHARA 5 CHOME OHTA-KU TOKYO 146-8515 JAPAN
 PHONE : 03-3751-9799 (+81 3 3751 9799)
 Email : info@rkcinst.co.jp
 FAX : 03-3751-8585 (+81 3 3751 8585)
<https://www.rkcinst.com/>