

REVELX

BUILD IT IN 13 VERSIONS

- Voltage Supply 480-600V
- OLED Display for easy Diagnostic & Configuration
- All types of Firing and Control Modes available
- Complies with EMC
- RS485 and USB port

CD AUTOMATION

POWERED BY INNOVATION



REVELX the REVO on demand
Innovation in Power Control
Build your REVELX



www.cdautomation.com
Revex Catalog 2020

WITH REVEX “YOU WILL FIND YOUR SOLUTION”

REVEX flexibility is built on its control circuitry

REVEX is a real Universal Unit where you can select:

- Input signal in digital mode, no link jumpers inside
- Firing mode: Single cycle, Half cycle, Burst, Phase Angle, Delayed Triggering, different types of adjustable ramp
- Control Mode (V, V2, I, I2, VxI)
- Communication RS485 with Modbus® protocol std.
- Two Analog input
- Two Digital input
- USB port to program REVEX, should you ever need to re-program from your ordered configuration
- With the units already programmed you can simply switch On and Go
- Save money and time straight out the box without the need to read a long manual
- Save money with REVEX and only pay for functionality you need (see the following pages)

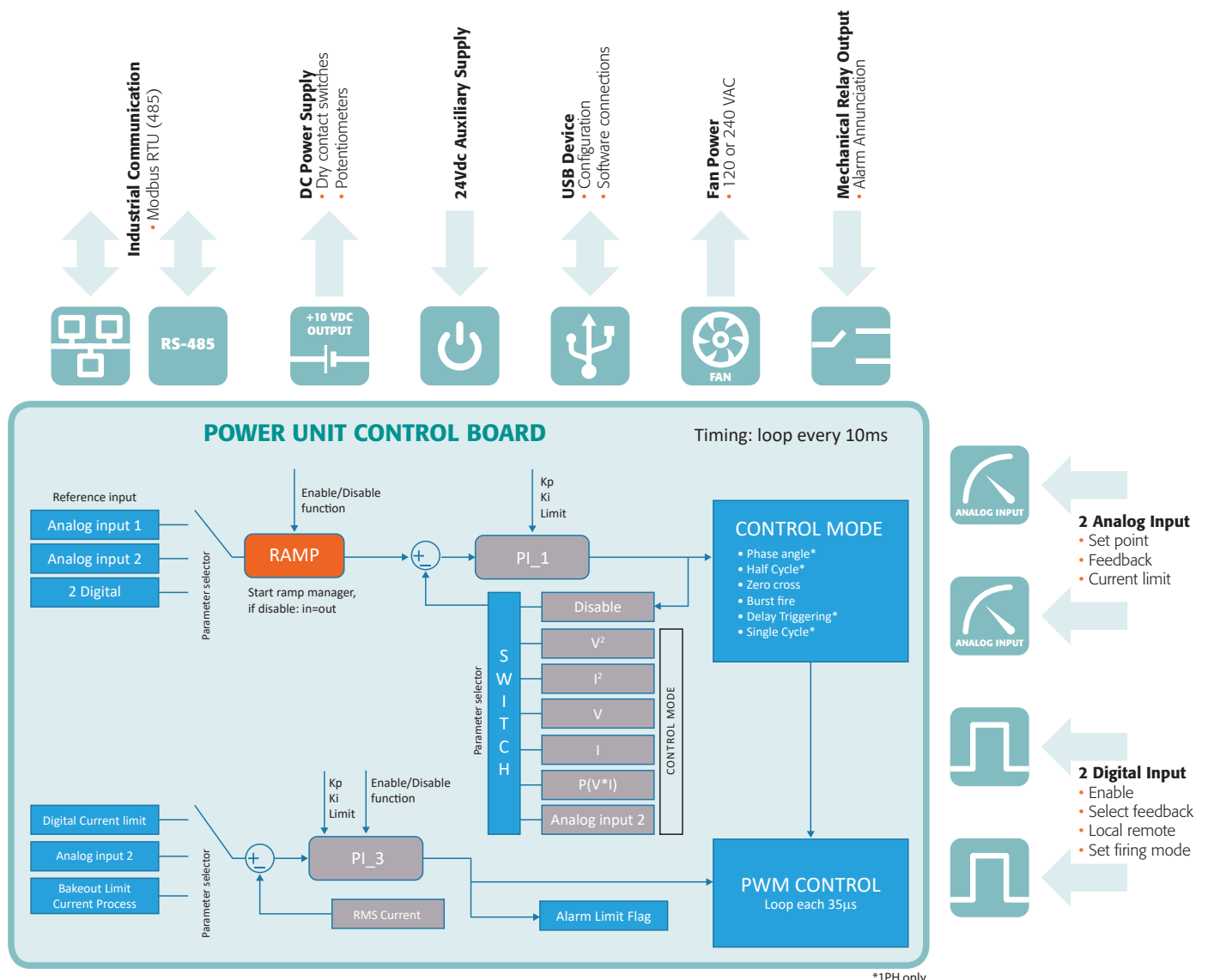

CONFIGURATOR SOFTWARE

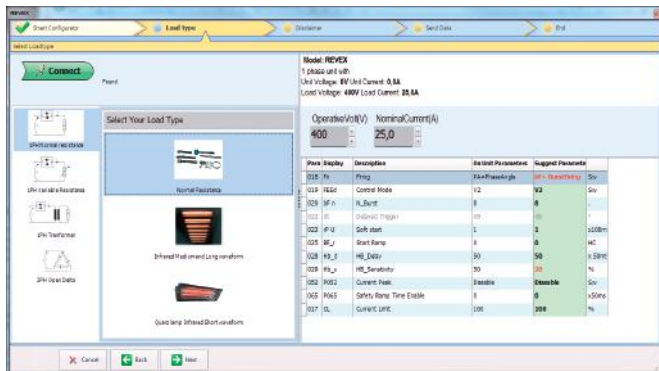

FAST TUNE

The all new powerful Thyristor Configurator Software allows you to configure all CD Automation products quickly and easily by using the FAST MODE. Simply select your application and the load type picture appears automatically, providing a list of suggested parameter settings. Depending on your application requirements, you can accept or make manual adjustments and when ready, download direct to the thyristor unit.

TEST UNIT

The TEST page is very useful when installing & commissioning CD Automation products as well as finding process issues or fine tuning at a later stage.

You can read, write, enable and disable key values and parameters to test your load. Examples include; reading voltage, current and power values, or current limit status, changing input types between analog or SSR, control (feedback) modes V, I and VxI, or select firing types half cycle, single cycle, burst firing, delayed triggering, phase angle and soft start.

The new 'Load Analyzer' (a small oscilloscope) can be activated from this page, see below.

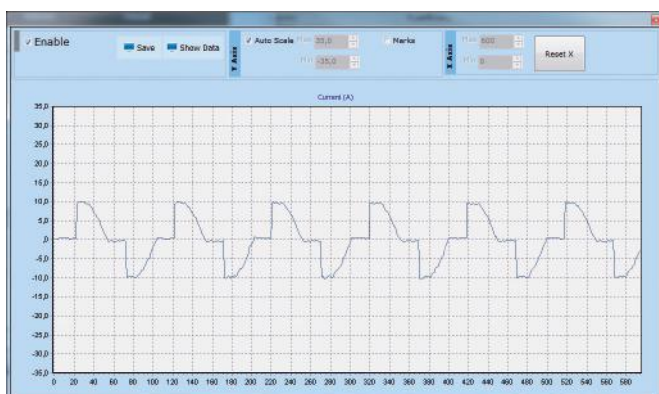
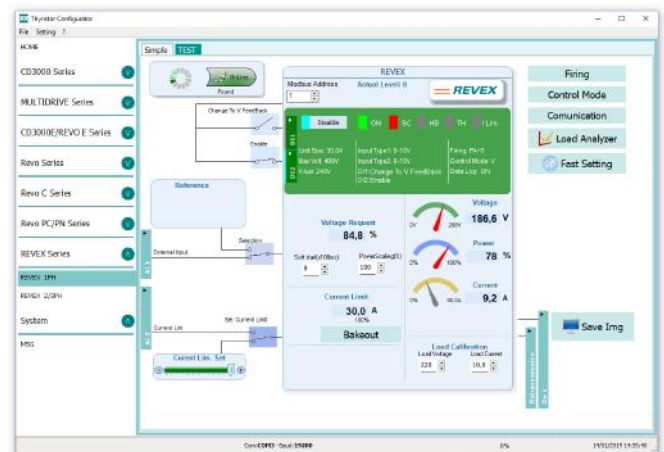

LOAD ANALYZER

Provides real-time information of the output waveform, where you can select up to 10 process variables to help the operator determine if the waveform is in line with process expectations. Also useful for trouble shooting.

REVEX THE POWER CONTROLLER ON DEMAND

REVEX offers total software and hardware flexibility

Available in a multitude of configurations:

- 16 different Modes for 1 Phase Units
- 8 different modes for 2 and 3 Phase Units

REVEX: superb flexibility in software and hardware

- Build your unit in line with Process Demand
- Typical examples shown below
- Fill list can be found in the Options Tab (see pages 8, 10 & 12)
- Field Bus available (see page 14)
- Modbus communication as standard



NO DISPLAY



1 Phase Power Control units in 30, 35 & 40A sizes with and without front panel display. Version without display can be programmed via the USB port.



NO DISPLAY



Shown are 1, 2 or 3 Phase Power Control units in 60 and 90A sizes.



NO FUSES



Available with or without fuses on the 60A and 90A units.

EVERY PRODUCT IS COMPREHENSIVELY TESTED

- Auxiliary Voltage test
- Current Sensor Calibration
- Analog Inputs Test and Calibration
- Digital inputs Test and Calibration (Example Heater Break Alarm)
- Customization of REVO based on Customer Code
- Digital Communication Test in Modbus®
- Each REVO have its own Precision Report that is safely stored in CD Automation secure database
- Unit fully tested for Input, Output and Control Mode and Firing

WITH THIS TYPE OF PROCEDURE WE ELIMINATE HUMAN MISTAKES

PRODUCTION

REVOX Product Line is Robotized to maintain quality standards and product repeatability



Another Robotized vehicle

PRODUCT MIGRATION

Older products are smoothly replaced with REVOX, guaranteeing painfree transition

REVEX FEATURES AND DIMENSIONS

	DESCRIPTION	REVEX 1PH	REVEX 2PH	REVEX 3PH
	CODE	RX1	RX2	RX3
LOAD TYPE	Max voltage 480V	●	●	●
	Max voltage 600V	●	●	●
	Single phase	●		
	3 phase load star no neutral or delta		●	●
	3 phase load star with neutral			●
	3 phase load open delta	●		
INPUT TYPE	SSR 4:30VDC	●	●	●
	4:20 mA	●	●	●
	0:10 Vdc	●	●	●
	Potentiometer	●	●	●
FIRING	Single Cycle	●		
	Half Cycle	●		
	Burst Firing	●	●	●
	Phase Angle	●		
	Delayed Triggering	●		
	Zero Crossing	●	●	●
CONTROL MODE	Open Loop	●	●	●
	Voltage	●	●	●
	Voltage square	●	●	●
	Current	●	●	●
	Current square	●	●	●
	Power V x I	●	●	●
OPTIONS	Current Limit CL	○		
	Heater Break Alarm + SCR Short Circuit	○	○	○
	Fuse	○	○	○
	Display	○	○	○
	Load Analyzer	●	●	●
COMM.	Modbus® RTU	●	●	●
CURRENT	CURRENT	SIZE	SIZE	SIZE
		600V Max	600V Max	600V Max
	30	SR6	SR9	SR10
	35	SR6	SR9	SR10
	40	SR6	SR9	SR10
	60	SR24	SR25	SR26
	90	SR25	SR25	SR26
	120	SR15	SR16	SR17
	150	SR15	SR16	SR17
	180	SR15	SR16	SR17
	210	SR15	SR16	SR17
	280	S10	2xS10	

● Standard ○ Option ■ CE standard

REVEX FAMILY SIZE AND DIMENSIONS

REVEX is a fully universal product range based upon powerful microprocessor technology. Available from 30A to 280A and single phase (1PH) plus 2PH & 3PH to drive 3 phase loads, its key benefit is its universality allowing inputs, all firing and control modes to be configured via front OLED display or via your personal computer and CD Automation's Configurator Software using USB port.

- When you buy REVEX, you also buy CD Automation's experience and know-how to drive your application
- With FastSetting you click on your application and you download the correct recipe
- You can build your REVEX in 13 different solutions
- Only pay for what you need



SR6 H 121 x W 36 x D 185 - 0,61 kg



SR9 H 121 x W 72 x D 185 - 1,15 kg



SR10 H 121 x W 108 x D 185 - 1,76 kg



SR24 H 169 x W 116 x D 183 - 2,10 kg



SR25 H 180 x W 116 x D 183 - 2,35 kg



SR26 H 180 x W 167 x D 183 - 2,70 kg



SR15 H 273 x W 93 x D 170 - 3,60 kg



SR16 H 273 x W 186 x D 170 - 7,00 kg



SR17 H 273 x W 279 x D 170 - 10,60 kg



S10 H 350 x W 120 x D 230 - 6,50 kg



2xS10 H 350 x W 240 x D 230 - 12,70 kg

REVEX 1PH



Technical Specification

- Dimensions:** See size and dimensions on page 7
- Load type:** Normal Resistance, Infrared Short, Medium and Long, Transformer Primary, Cold resistance and SiC elements
- Inputs:** 4:20mA, 0:10V, SSR and ModBus as std.
- Firing mode:** Half Cycle, Single Cycle, Burst Firing, Delayed Triggering, Phase Angle with or without Soft Start
- Control Mode:** Voltage, Current and Power or V2 and I2 with additional Transfer to VxI
- Communication:** RS485 port. RTU Modbus® Protocol
- USB:** Port integrated for configuration in safety mode (No Load and Auxiliary Voltage needed) Unit Powered Through USB
- Approvals:** Comply with EMC
- Dual Current Limit:** For peak and RMS value

Option

- All options are shown below with the relevant model code
- HB Alarm to diagnose partial or Total Load Failure and Thyristor Short Circuit

Tools

- A very easy and Powerful Configurator Software is available Free of Charge on www.cdautomation.com

Option Code Table (digit 12)

REVEX 1PH from 30 to 40A					REVEX 1PH from 60 to 280A					Discount EXAMPLE for REVEX 1PH 150A 480V CE*	
Current Limit	Heater Break	Display		Option Code (digit 12)	Current Limit	Heater Break	Fuse	Display			Option Code (digit 12)
Y	Y	Y	Full option price list (FOPL)	0	Y	Y	Y	Y	Full option price list (FOPL)	0	
					Y	Y	Y	N	Discount	1	-5% less than FOPL
Y	Y	N	Discount	2	Y	Y	N	N	Discount	2	-7% less than FOPL
Y	N	N	Discount	3	Y	N	N	N	Discount	3	-10% less than FOPL
N	N	N	Discount	4	N	N	N	N	Discount	4	-14% less than FOPL
					Y	Y	N	Y	Discount	5	-2% less than FOPL
Y	N	Y	Discount	6	Y	N	N	Y	Discount	6	-5% less than FOPL
N	N	Y	Discount	7	N	N	N	Y	Discount	7	-9% less than FOPL
					N	Y	Y	N	Discount	8	-9% less than FOPL
N	Y	Y	Discount	9	N	Y	N	Y	Discount	9	-6% less than FOPL
					N	N	Y	Y	Discount	A	-7% less than FOPL
					N	N	Y	N	Discount	B	-12% less than FOPL
					N	Y	Y	Y	Discount	C	-4% less than FOPL
N	Y	N	Discount	D	N	Y	N	N	Discount	D	-11% less than FOPL
					Y	N	Y	N	Discount	E	-8% less than FOPL
					Y	N	Y	Y	Discount	F	-3% less than FOPL

N Option you want removed **Y** It serves my project

*The discount applied is based on the size and options removed.

REVEX 1PH CODING



RS-485

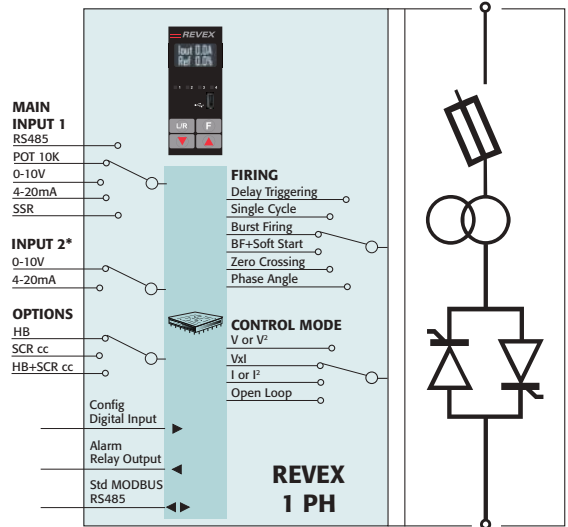

ORDER CODE:

	1	2	3	4	5	6		7	8	9	10	11	12	13	14	15	16
REVEX 1PH	R	X	1	-	-	-	-	-	-	-	-	-	-	-	-	-	-

CURRENT	FUSES	4	5	6
description	description	code		
30A	External Fuse (not included in basic price)	0	3	0
35A	External Fuse (not included in basic price)	0	3	5
40A	External Fuse (not included in basic price)	0	4	0
60A	Fixed Fuses Included	0	6	0
90A	Fixed Fuses Included	0	9	0
120A	Fixed Fuses Included	1	2	0
150A	Fixed Fuses Included	1	5	0
180A	Fixed Fuses Included	1	8	0
210A	Fixed Fuses Included	2	1	0
280A	Fixed Fuses Included	2	8	0

MAX VOLTAGE	7
description	code
480V	4
600V	6

MAIN SUPPLY VOLTAGE	8
description	code
24Vdc	4

MAIN INPUT	9
description	code
SSR	S
0:20mA	B
4:20mA	A
0:10V	V
10KPot	K

FIRING	START OPTION	10
description	description	code
Single Cycle	No Soft Start	C
	Linear Soft Starter	S
	No Soft Start	H
Half Cycle	Linear Soft Starter	L
	Soft Start for short wave Infrared Lamp	I
	No Soft Start	B
Burst Firing	Linear Soft Starter	J
	No Soft Start	P
	Linear Soft Starter	E
Phase Angle	No Soft Start	D
	Linear Soft Starter	T
	No Soft Start	Z
Delayed Triggering	Linear Soft Starter	R
	No Soft Start	
Zero Crossing	Linear Soft Starter	
	No Soft Start	

CONTROL MODE	11
description	code
Open Loop	0
Voltage	U
Voltage Square	Q
Current	I
Current Square	A
Power VxI	W
External Feedback	X

OPTION	12
description	code
Option code - see previous page table	-

FAN VOLTAGE	13
description	code
No Fan < 90A	0
Fan 24Vdc ≥ 90A	3

APPROVALS	14
description	code
CE EMC For European Market	0

LOAD TYPE	15
description	code
1 PH Normal Resistance	0
1 PH IRSW Infrared Short Wave	1
1 PH MoSi2 Heaters	2
1 PH SiC Heaters	3
1 PH Transformer Coupled with Normal Resistance	4
1 PH Transformer Coupled with MoSi2 Heaters	5
1 PH Transformer Coupled with SiC Heaters	6
1 PH Transformer Coupled with UV Lamp	7

COMMUNICATION AND RETRANSMISSION	16
description	code
N°1 Modbus® RTU std.	0

Configuration Cable

	1	2	3
ORDERING CODE	C	C	X
description	Micro USB Cable for REVEX and REVO C		

REVEX 2PH



SIZE SR9



SIZE SR25



SIZE SR16



SIZE 2xS10

Technical Specification

- Dimensions:** See size and dimensions on page 7
- Load type:** Normal Resistance, Infrared Short, Medium and Long waveform
- Inputs:** 4:20mA, 0:10V, SSR and Modbus® as std.
- Firing mode:** Burst Firing, Zero Crossing.
- Control Mode:** Voltage, Current and Power or V2 and I2
- Communication:** RS485 port. RTU Modbus® Protocol
- USB:** Port integrated for configuration in safety mode (No Load and Auxiliary Voltage needed) Unit Powered Through USB
- Approvals:** Comply with EMC

Option

- All options are shown below with the relevant model code
- HB Alarm to diagnose partial or Total Load Failure and Thyristor Short Circuit

Tools

- A very easy and Powerful Configurator Software is available Free of Charge on www.cdautomation.com

Option Code Table (digit 12)

REVEX 2PH from 30 to 40A				REVEX 2PH from 60 to 280A					Discount EXAMPLE for REVEX 2PH 150A 480V CE*
Heater Break	Display		Option Code (digit 12)	Heater Break	Fuse	Display		Option Code (digit 12)	
Y	Y	Full option price list (FOPL)	0	Y	Y	Y	Full option price list (FOPL)	0	
				Y	Y	N	Discount	1	-4% less than FOPL
Y	N	Discount	2	Y	N	N	Discount	2	-7% less than FOPL
N	N	Discount	3	N	N	N	Discount	3	-9% less than FOPL
				Y	N	Y	Discount	4	-3% less than FOPL
N	Y	Discount	5	N	N	Y	Discount	5	-5% less than FOPL
				N	Y	Y	Discount	6	-2% less than FOPL
				N	Y	N	Discount	7	-6% less than FOPL

N Option you want removed **Y** It serves my project

*The discount applied is based on the size and options removed.

REVEX 2PH CODING



RS-485

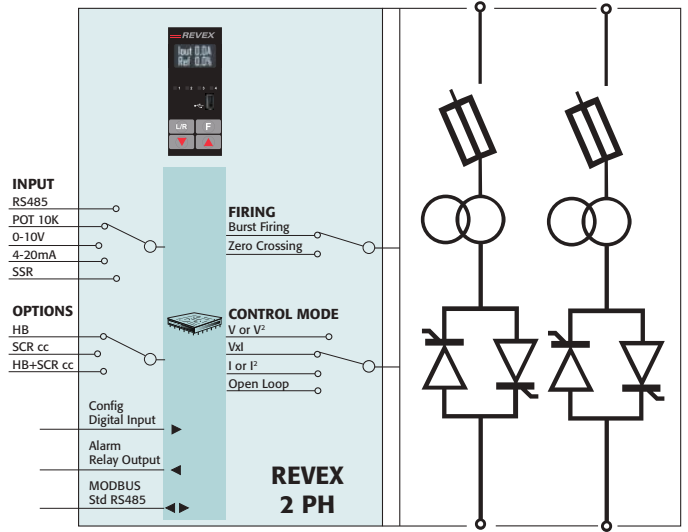

ORDER CODE:

	1	2	3	4	5	6	7	8	9	10	11	12	13	14	15	16
REVEX 2PH	R	X	2	-	-	-	-	-	-	-	-	-	-	-	-	-

CURRENT	FUSES	4	5	6
description	description	code		
30A	External Fuses (not included in basic price)	0	3	0
35A	External Fuses (not included in basic price)	0	3	5
40A	External Fuses (not included in basic price)	0	4	0
60A	Fixed Fuses Included	0	6	0
90A	Fixed Fuses Included	0	9	0
120A	Fixed Fuses Included	1	2	0
150A	Fixed Fuses Included	1	5	0
180A	Fixed Fuses Included	1	8	0
210A	Fixed Fuses Included	2	1	0
280A	Fixed Fuses Included	2	8	0

MAX VOLTAGE	7
description	code
480V	4
600V	6

MAIN SUPPLY VOLTAGE	8
description	code
24Vdc	4

MAIN INPUT	9
description	code
SSR	S
0:20mA	B
4:20mA	A
0:10V	V
10KPot	K

FIRING	START OPTION	10
description	description	code
Burst Firing	No Soft Start	B
Zero Crossing	No Soft Start	Z

CONTROL MODE	11
description	code
Open Loop	0
Voltage	U
Voltage Square	Q
Current	I
Current Square	A
Power VxI	W
External Feedback	X

OPTION	12
description	code
Option code - see previous page table	-

FAN VOLTAGE	13
description	code
No Fan < 60A	0
Fan 24Vdc ≥ 60A	3

APPROVALS	14
description	code
CE EMC For European Market	0

LOAD TYPE	15
description	code
Normal Resistive Load with 3 Phase Star without neutral Connection	0
Normal Resistive Load with 3 Phase Delta Connection	1
IRSW Infrared Short wave with 3 Phase Star Connection	2
IRSW Infrared Short wave with 3 Phase Delta Connection	3

COMMUNICATION AND RETRANSMISSION	16
description	code
N°1 Modbus® RTU std.	0

Configuration Cable

	1	2	3
ORDERING CODE	C	C	X
description	Micro USB Cable for REVEX and REVO C		

REVEX 3PH



SIZE SR10



SIZE SR26



SIZE SR17

Technical Specification

- Dimensions:** See size and dimensions on page 7
- Load type:** Normal Resistance, Infrared Short, Medium and Long
- Inputs:** 4:20mA, 0:10V, SSR and Modbus® as std.
- Firing mode:** Burst Firing, Zero Crossing
- Control Mode:** Voltage, Current and Power or V2 and I2 with additional Transfer to VxI
- Communication:** RS485 port. RTU Modbus® Protocol
- USB:** Port integrated for configuration in safety mode (No Load and Auxiliary Voltage needed) Unit Powered Through USB
- Approvals:** Comply with EMC

Option

- All options are shown below with the relevant model code
- HB Alarm to diagnose partial or Total Load Failure and Thyristor Short Circuit

Tools

- A very easy and Powerful Configurator Software is available Free of Charge on www.cdautomation.com

Option Code Table (digit 12)

REVEX 3PH from 30 to 40A				REVEX 3PH from 60 to 280A				Discount EXAMPLE for REVEX 3PH 150A 480V CE*
Heater Break	Display		Option Code (digit 12)	Heater Break	Fuse	Display	Option Code (digit 12)	
Y	Y	Full option price list (FOPL)	0	Y	Y	Y	Full option price list (FOPL)	0
Y	N	Discount	2	Y	Y	N	Discount	1
N	N	Discount	3	Y	N	N	Discount	2
N	Y	Discount	5	N	N	N	Discount	3
				Y	N	Y	Discount	4
				N	N	Y	Discount	5
				N	Y	Y	Discount	6
				N	Y	N	Discount	7
								-3% less than FOPL
								-6% less than FOPL
								-8% less than FOPL
								-3% less than FOPL
								-5% less than FOPL
								-2% less than FOPL
								-5% less than FOPL

N Option you want removed **Y** It serves my project

*The discount applied is based on the size and options removed.

REVEX 3PH CODING

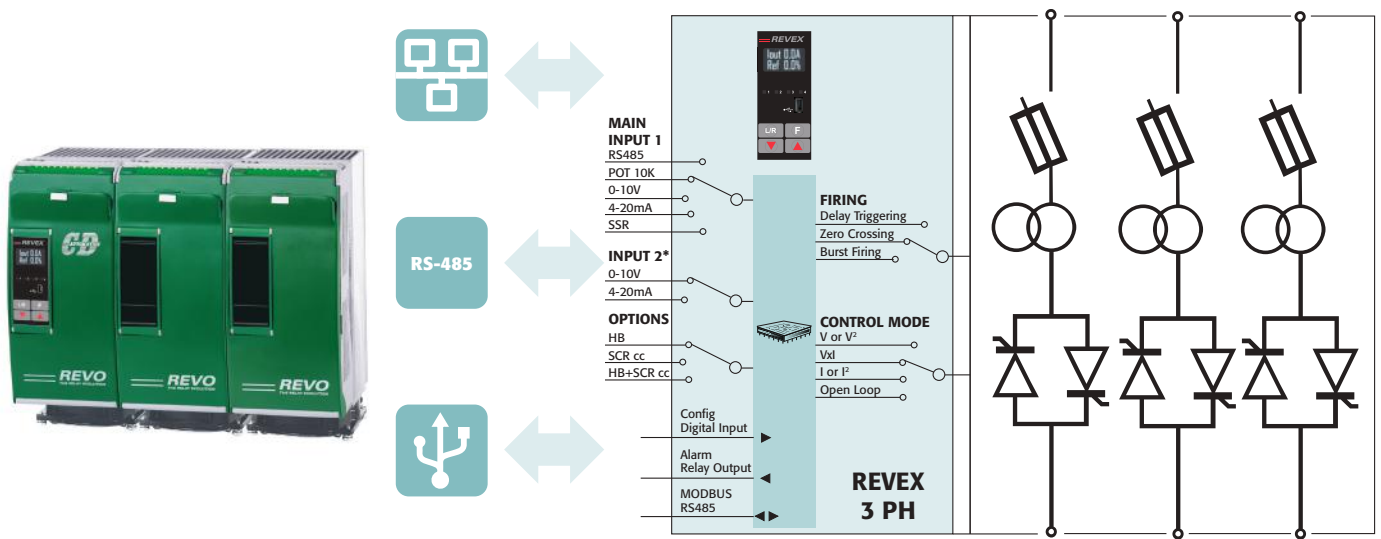

ORDER CODE:

	1	2	3	4	5	6	7	8	9	10	11	12	13	14	15	16
REVEX 3PH	R	X	3	-	-	-	-	-	-	-	-	-	-	-	-	-

CURRENT	FUSES	4	5	6
description	description			
30A	External Fuses (not included in basic price)	0	3	0
35A	External Fuses (not included in basic price)	0	3	5
40A	External Fuses (not included in basic price)	0	4	0
60A	Fixed Fuses Included	0	6	0
90A	Fixed Fuses Included	0	9	0
120A	Fixed Fuses Included	1	2	0
150A	Fixed Fuses Included	1	5	0
180A	Fixed Fuses Included	1	8	0
210A	Fixed Fuses Included	2	1	0

MAX VOLTAGE	7
description	code
480V	4
600V	6

MAIN SUPPLY VOLTAGE	8
description	code
24Vdc	4

MAIN INPUT	9
description	code
SSR	S
0:20mA	B
4:20mA	A
0:10V	V
10KPot	K

FIRMING	START OPTION	10
description	description	code
Burst Firing	No Soft Start	B
Zero Crossing	No Soft Start	Z

CONTROL MODE	11
description	code
Open Loop	0
Voltage	U
Voltage Square	Q
Current	I
Current Square	A
Power VxI	W
External Feedback	X

OPTION	12
description	code
Option code - see previous page table	-

FAN VOLTAGE	13
description	code
No Fan < 60A	0
Fan 24Vdc ≥ 60A	3

APPROVALS	14
description	code
CE EMC For European Market	0

LOAD TYPE	15
description	code
Normal Resistive Load with 3 Phase Star Connection with neutral	0
Normal Resistive Load with 3 Phase Delta or Star Connection	1
IRSW Infrared Short wave with 3 Phase Star Connection with neutral	2
IRSW Infrared Short wave with 3 Phase Delta or Star Connection	3

COMMUNICATION AND RETRANSMISSION	16
description	code
N°1 Modbus® RTU std.	0

Configuration Cable

	1	2	3
ORDERING CODE	C	C	X
description	Micro USB Cable for REVEX and REVO C		

FIELD BUS Module



Technical Specification

- Up to n°14 REVEX can be connected for each terminal module
- Secondary communication port to connect REVO HMI
- Main process variable available
- 24Vdc Power Supply
- Simplified configuration

	1	2		3	4	5	6	7		8	9	10	11	12	13	14	15	16
ORDERING CODE	T	U	-	R	S	4	8	5	-	-	-	-	-	-	-	-	-	-

FIELD BUS OR COMMUNICATION	8	9	10	
description	code			note
N° 1 Modbus TCP + N° 1 Modbus RTU slave	T	C	P	
N° 1 ProfiNet IO + N° 1 Modbus RTU slave	P	N	T	
N° 1 ProfiBus DP + N° 1 Modbus RTU slave	P	D	P	
N° 1 Ethernet IP + N° 1 Modbus RTU slave	E	I	P	

SECONDARY COMMUNICATION PORT	11	
description	code	note
None	0	
Modbus TCP	1	1

CONFIGURATION	12	13	14	
description	code			note
REVEX 1-2-3PH	R	V	X	

N° ZONES	15	16	
description	code	code	note
Not configured	0	0	2
1 zone	0	1	
2 zones	0	2	
3 zones	0	3	
4 zones	0	4	
5 zones	0	5	
6 zones	0	6	
7 zones	0	7	
8 zones	0	8	
9 zones	0	9	
10 zones	1	0	
11 zones	1	1	
12 zones	1	2	
13 zones	1	3	
14 zones	1	4	

Note (1): Not available with Modbus TCP Field Bus Communication (T-C-P on digit 8-9-10)

Note (2): It's possible to manage from 1 to 14 zones with basic read and write configuration (see the Manual). If you need a different version please use the code "00".

DIN-RAIL mount semiconductor fusing

Protection for your REVEX 1-2-3PH 30-40A power controllers

For efficient protection of your REVEX power controller, use semiconductor fuses to ensure a long life.

All Fuses should be rated at 25% more than Power Controller rating.

The semiconductor I_{pt} should be 30% less than REVEX Power Controller I_{pt}.

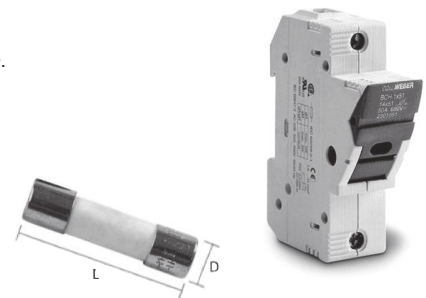

CE version	SPARE FUSES					
	Unit	Amp Rating	I _{pt} (A2 Sec)	Code	Diameter	Length
	30A	40	525	FU1451/40A	14	51
	35A	50	1260	FU1451/50A	14	51
	40A	50	1260	FU1451/50A	14	51
	FUSE and FUSE HOLDER					
	Unit	1PH (1 off)	2PH (3 off)	3PH (3 off)		
	30A	FFH1451/40A (1 off)	FFH1451/40A (3 off)	FFH1451/40A (3 off)		
	35A	FFH1451/50A (1 off)	FFH1451/50A (3 off)	FFH1451/50A (3 off)		
	40A	FFH1451/50A (1 off)	FFH1451/50A (3 off)	FFH1451/50A (3 off)		

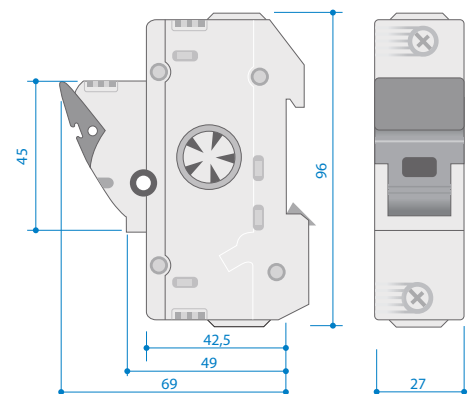

GENERAL FEATURES

Display Software

0.1	OLED display on front Unit	This display improves the operator interface and delivers use-friendly intuitive messages
0.2	Diagnostic	Powerful diagnostics provides clear alarm notification in plain English on the OLED display
0.3	Fully Software Configurable	REVEX is fully Software configurable
0.4	Layer based Firmware	Layered software design means that new application or customer software can be written without a complete software debug, resulting in faster upgrades and a stable platform

Electrical Features

1.1	Current rating	30 to 280A for 1-2-3 Phase unit (280A Not Available on 3 Phase)
1.2	Voltage	480-600V
1.3	Integrated Fuse	Reduces labour time and cabinet space compared to external fusing whilst benefiting from internal fan cooling helping to reduce fuse temperature
1.4	Quick and easy access to Fuses	Fuses and thyristors are mounted directly behind the front panel door. Fuses not included in size 30-35-40A (see page 14 to have External Fuse + Fuse Holder)

Firing & Control Mode

2.1	Universal firing mode	Half Cycle, Single Cycle, Burst Firing, Delayed Triggering Phase Angle and Soft Start
2.2	Current Control	This feature is available for both RMS and peak Control
2.3	Voltage Control	Normally used when Voltage Control Mode is selected
2.4	Power Control	Normally used when Power Control Mode is selected
2.5	Universal Input	The std analog inputs 4:20mA and 0:10V and SSR Configurable via Software
2.6	Universal Control Mode	REVEX can be configured for Current, Voltage Power feed back or open loop
2.7	External Feed Back	External selection of the Control Mode (Feedback) via 0-10V signal

Communication

3.1	Modbus® RTU	Standard
3.2	USB device on front unit for configuration	Allows the user to easily and safely configure the REVEX unit by powering through the USB connection only, without connecting a standard voltage line supply

Extra Features

4.1	Special Algorithm for Short Wave form IR Lamp	Using half cycle firing and soft start curve to minimize lamp flickering
4.2	Automatic Selection of the configuration	Automatically select the correct parameters for your application via Configurator Software by using the wiring and load type icons via PC configuration software
4.3	HB and Sc Alarm	Alarm for Partial or Total Load Failure and Short Circuit on SCR with Electromechanical Relay output 1A at 30Vdc or 0,5A at 125Vac
4.4	Heater Bakeout	Protects heater elements on start-up by eliminating problems caused by moisture ingress
4.5	High precision measurement (True RMS Value for V, I and VxI)	≤1%
4.6	Free configuration Software	Easy to use and powerful Configurator Software, available free of charge from www.cdautomation.com

General Features and Approvals

5.1	Industry-leading and Serviceability	Generous sizing of Thyristors and Thermal Parts using high efficiency Heatsink
5.2	Enable troubleshooting with helpful thermal system diagnostics	Internal temperature sensor detects over-current or high cabinet temperature and raises alarm. If high temperature continues a second high limit alarm powers down the thyristor unit
5.3	Fully compatible with REVO M and REVO CL, CD3000M and CD3200 series. REVEX will manage the migration of the products above described	Fully upgrade & substitute existing REVO M and REVO CL and CD3200 units using the same terminal blocks and wiring
5.4	Approvals	CE-EMC 480-600V versions is available on request



Italy

CD Automation Srl
Via Picasso, 34/36
20025 Legnano MI
Italy
T +39 0331 577479
F +39 0331 579479
sales@cdautomation.com
www.cdautomation.com

India

M/s Toshcon CD Automation Pvt. Ltd.
H1 - 75 Gegal Industrial Area
Ajmer - 305023 (Raj.)
India
T +91 145 2791112
T +91 145 6450601/2/3
sales.cd@toshcon.com
www.cdautomation.in

England

CD Automation UK Ltd
Unit 9 Harvington Business Park
Brampton Road, Eastbourne
East Sussex, BN22 9BN
England
T +44 1323 811100
info@cdautomation.co.uk
www.cdautomation.co.uk