



SA200



General Description

The SA200 is a high performance 32nd DIN controller that has been specifically designed for applications where panel space is critical. Though small in size, this controller has exceptional features such as dual display of process and set value, mounting flexibility, advanced self-tuning, alarms and MODBUS communications.

Features

- ☆ 1/32 DIN size with dual display
- ☆ 4-20mA output for control/retransmission
- ☆ Dual setpoint
- ☆ PV ratio, Peak/Bottom hold, Ramp-to-setpoint¹
- ☆ Loop break alarm and temperature alarms
- ☆ Digital communications

¹ Contact RKC or RKC distributors.

Close Vertical or Horizontal Mounting



The SA200 has been designed with a unique mounting bracket that allows close vertical or horizontal of multiple instruments to save valuable panel space. However, there is a maximum of six units in either direction with this type of installation.

Self-Tuning Algorithm

The SA200 offers a new self-tuning feature that is initiated at start-up and when process parameters or conditions change. In these situations, the controller evaluates whether the preset PID parameters should be maintained or replaced by the latest self-tuning parameters to achieve the best control for the process. Self-tuning can be manually turned ON/OFF in the parameter setting mode. This feature is not available with the Heat/Cool control.

In addition to self-tuning, the SA200 has standard autotuning (AT) so that either function can be selected to achieve optimum process control.

Two types of Dual-Display Color

The SA200 has a dual-display with a larger green display (PV) and small orange display (SV). Red/Red display is also available with SA201.

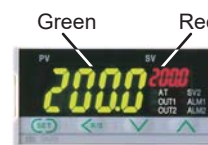

SA200

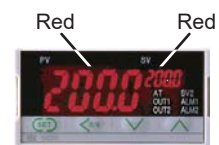

SA201

Digital Communications (Optional)

The SA200 offers an optional RS-485 communications interface for networking to computers, PLCs and SCADA software. MODBUS or ANSI protocol can be selected. Up to 32 units, including host computer, can be multi-dropped on one RS-485 communication line. When the communication feature is selected, the external contact input is not available.

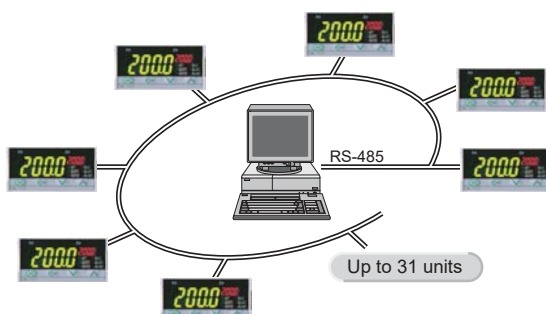

Waterproof/Dustproof (Optional)

For operation in severe environments or when washdown is required, the IP66 (NEMA4) rating is available for waterproof /dustproof protection.



Temperature Controller SA200

Features

Loop Break Alarm and Temperature Alarms (Optional)

The loop break alarm (LBA) monitors and protects an entire temperature control system. The LBA detects heater breaks, thermocouple or RTD failures, short circuits, or the failure of an operating device such as a mechanical or solid state relay.

When the PID computed value reaches 100% and the temperature does not respond in a set time, the loop break alarm is activated. Conversely, when the PID value reaches 0% and the temperature does not respond accordingly, the loop break alarm is turned on. In this example, the LBA uses reverse action to control heat. For cool control, the LBA action is reversed and becomes direct. LBA deadband is available to suppress the influence of external disturbances.

In addition to the loop break alarm, the SA200 offers field-programmable temperature alarms. Deviation (High, Low, High/Low), process (High, Low), set value (High, Low) and band alarms can be selected.

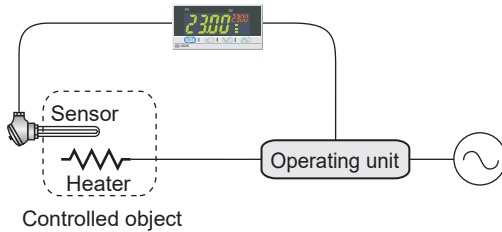

Digital Contact Input for External Switching (Optional)

An optional digital contact input is available for RUN/STOP and SV1/SV2, alarm interlock release switching. (RUN/STOP switching can also be completed at the front key panel.) This function can be used with the output from a timer, PLC, etc. When the communication feature is selected, the external contact input is not available.

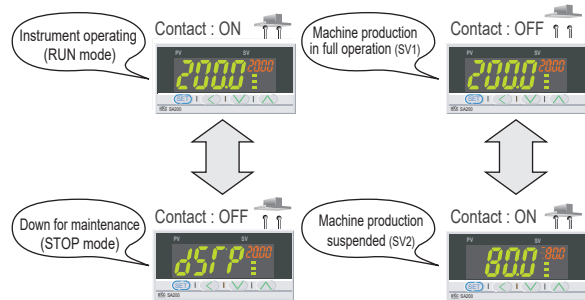

Easy Maintenance

The internal assembly of the SA200 can be removed from the front of a control board. It is easy to inspect, maintain or replace the instrument because it does not require access from the back of the panel.



Heat/Cool Control (Optional)

The Heat/Cool PID control features heat and cool outputs for use where process-generated heat exists. This allows the input of overlap or deadband settings which contribute to energy savings.

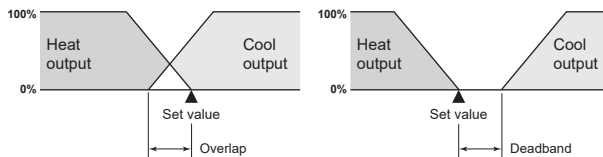

Analog Retransmission Output (Optional)

The output 1 can be configured as an analog retransmission output. With this function, the measured value can be retransmitted as an analog current signal (4-20mA / 0-20mA).

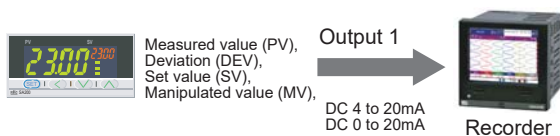



Specifications

Input

Input

- a) Thermocouple : K, J, E, T, R, S, B, N (JIS/IEC), PLII (NBS)
W5Re/W26Re(ASTM), U, L (DIN)
- Input impedance : Approx. 1MΩ
 - Influence of external resistance : Approx. 0.2μV/Ω
 - Input break action : Up-scale *1
- b) RTD : Pt100(JIS/IEC), JPt100(JIS)
- Influence of lead resistance : Approx. 0.01[%/Ω] of span
 - Maximum 10Ω per wire
 - Input break action : Up-scale *1
 - Input short action : Down-scale
- c) DC voltage : 0 to 5V DC, 1 to 5V DC, 0 to 10V DC
- d) DC current : 0 to 20mA DC, 4 to 20mA DC
- For DC current input, connect a 250 Ω resistor to the input terminals.
 - Input break action : Down-scale *1
 - Reading is around zero for 0 to 5V DC input, 0 to 10V DC input and 0 to 20mA DC input.
- *1: Both Heat/Cool control outputs are OFF for Heat/Cool PID action.

Sampling Time

0.5 sec. 0.25sec (Selectable)

Input Digital Filter

1 to 100 sec (OFF when 0 is set.)

PV Bias

- span to +span (Within -1999 to 9999)

Performance

Measuring Accuracy

- a) Thermocouple
- ±(0.3% of reading + 1 digit) or ±2°C (4°F) whichever is larger
 - Accuracy is not guaranteed less than 399°C (0 and 799°F) for type R, S and B.
 - Accuracy is not guaranteed less than -100.0°C (-158.0°F) for type T and U.
- b) RTD
- ±(0.3% of reading + 1 digit) or ±0.8°C (1.6°F) whichever is larger
- c) DC voltage and DC current
- ±(0.3% of span + 1 digit)

Insulation Resistance

More than 20MΩ (500V DC) between measured terminals and ground
More than 20MΩ (500V DC) between power terminals and ground

Dielectric Strength

1500V AC for one minute between measured terminals and ground
1500V AC for one minute between power terminals and ground

Control

Control Method

- a) PID control (with autotuning and self-tuning function)
- Available for reverse and direct action.
 - ON/OFF, P, PI and PD control are also selectable.
- b) Heat/Cool PID control (with autotuning function)
- Air cooling and water cooling type are available. (Specify when ordering.)

Major Setting Range

Set value : Same as input range.
Heat side proportional band : 1 to span or 0.1 to span
(ON/OFF action when P=0)
Cool side proportional band : 1 to 1000% of heat side proportional band
Integral time : 1 to 3600sec. (PD action when I=0)
Derivative time : 1 to 3600sec. (PI action when D=0)
Anti-Reset Windup (ARW) : 1 to 100% of heat side proportional band
(Integral action is OFF when ARW=0)
Proportional cycle time : 1 to 100 sec.
Deadband/Overlap : -span to +span (Within -1999 to 9999)

Outputs

Output

- Can be set for control or alarm functions.
 - Alarm output can be set for energized/de-energized action.
 - Alarm output can be set for AND/OR logic calculation.
- Number of outputs : 2 points

Output Type

- Relay contact output : 240V AC, 30V DC 2A (resistive load),
Form A contact
- Voltage pulse output : 0/12V DC (Load resistance : more than 600Ω)
- Operational Insulation between measurement input terminals and output terminals.
- Current output : 0 to 20mA, 4 to 20mA DC
(Load resistance : less than 400Ω)
- Operational Insulation between measurement input terminals and output terminals.
 - Available for output 1.

Alarms (Up to 2 points)

(Optional)

Alarm Type

Deviation High, Deviation Low, Deviation High-Low, Deviation Band
Process High, Process Low, Set value High, Set value Low
Loop break alarm(LBA)

Setting Range

- a) Deviation alarm : -span to +span (Within -1999 to 9999)
b) Process alarm : Same as set value (SV).
c) Set value alarm : Same as set value (SV).
d) Loop break alarm : 0.0 to 200.0 min.

Differential Gap

2°C (°F) or 2.0°C (°F) (Temperature input), 0.2% (Voltage, current input)

Contact Input

(Optional)

Number of Inputs : 2 points

Contact Input Type

- a) RUN/STOP switching (OPEN : STOP, CLOSE : RUN)
b) STEP function (OPEN : SV1, CLOSE : SV2)
c) Alarm interlock release ON or OFF.

Input Rating

Non-voltage contact input. (OPEN : 500kΩ or more, CLOSE : 10Ω or less)

Analog Retransmission Output (Optional)

Number of Outputs

1 point (Output 1)

Output types

Measured value (PV), Deviation (DEV), Set value (SV),
Manipulated value (MV),
• Selectable

Output Signal

Current output (Output 1)
4 to 20mA DC, 0 to 20mA DC (Load resistance : Less than 400Ω)

Communications

(Optional)

- a) Communication method : Based on RS-485 (2-wire)
b) Communication speed : 2400, 4800, 9600, 19200, 38400, 57600 BPS
c) Protocol : ANSI X3.28(1976) 2.5 A4, MODBUS
d) Bit format
Start bit : 1, Data bit : 7 or 8 •For MODBUS 8 bit only
Parity bit : Without, Odd or Even, Stop bit : 1 or 2
e) Maximum connection : 31 (Address can be set from 0 to 99.)

Waterproof/Dustproof

(Optional)

Dustproof and waterproof protection : IP66

- Waterproof/dustproof protection only effective from the front in panel mounted installations.
- Waterproof/dustproof protection is not available when controllers are closely mounted.

General Specifications

Supply Voltage

- a) 85 to 264V AC (Including supply voltage variation)
[Rating : 100 to 240V AC] (50/60Hz common)
b) 21.6 to 26.4V AC (Including supply voltage variation)
[Rating : 24V AC] (50/60Hz common)
c) 21.6 to 26.4V DC (Ripple rate 10% p-p or less)
[Rating : 24V DC]

Power Consumption

Less than 4VA (at 100V AC), 7VA (at 240V AC) for standard AC type
Less than 4VA for 24V AC type
Less than 100mA for 24V DC type

Power Failure Effect

A power failure of 20 ms or less will not affect the control action.
If power failure of more than 20 ms occurs, controller will restart.

Operating Environments : -10 to 55°C [14 to 131°F] , 5 to 95% RH

Memory Backup : Backed up by non-volatile memory.

Number of writing : Approx. 100,000 times

Net Weight : Approx. 110g

External Dimensions (W x H x D) : 48 x 24 x 100mm (1/32 DIN)

Compliance with Standards

- UL : UL 61010-1
- cUL : CAN/CSA-C22.2 No.61010-1
- CE Mark
- LVD : EN61010-1, EMC: EN61326-1, RoHS: EN IEC 63000
- RCM : EN55011
- UKCA Mark
- Electrical Safety: EN61010-1, EMC: EN61326-1, RoHS: EN IEC 63000



Temperature Controller SA200

Model and Suffix Code

Specifications	Model and Suffix Code											
Model	SA200 (1/32 DIN size)											
Control method	PID control with AT (reverse action) F PID control with AT (direct action) D Heat/cool PID control with AT (water cooling) W Heat/cool PID control with AT (air cooling) A											
Input and Range	See Range and Input Code Table											
Output 1 (OUT 1) (Control, alarm or re-transmission output)	Relay contact output Voltage pulse output 0-20mA output 4-20mA output						M V 7 8					
Output 2 (OUT 2) (Control or alarm output)	No output Relay contact output Voltage pulse output						N M V					
Power supply voltage	24V AC/DC 100 to 240V AC						3 4					
Alarm 1	No alarm See Alarm Code Table											
Alarm 2	No alarm See Alarm Code Table											
Communication Contact input	Not supplied Digital communications : RS-485 (RKC standard) Digital communications : RS-485 (MODBUS) External contact input											
Waterproof/Dustproof	Not supplied Waterproof/Dustproof protection											
Body color	White Black											
Output allocation code ¹	Standard output See Output Allocation Code Table											
Instrument version	Version symbol											

¹ When standard output is selected with control method F or D, Out 1 will always be the control output and Out 2 will either be unused, Alarm 1 or OR logic output of Alarm 1 and Alarm 2. Standard output is automatically selected with control method W or A. Out 1 will become heat-side control output and Out 2 will be cool-side control output.

Range and Input Code Table

Thermocouple input (Field-programmable)

Input	Code	Range
K (JIS/IEC)	K : 01	0 – 200°C
	K : 02	0 – 400°C
	K : 03	0 – 600°C
	K : 04	0 – 800°C
	K : 05	0 – 1000°C
	K : 06	0 – 1200°C
	K : 07	0 – 1372°C
	K : 13	0 – 100°C
	K : 14	0 – 300°C
	K : 20	0 – 500°C
	K : 17	0 – 450°C
	K : 08	-199.9 – 300.0°C
	K : 09	0.0 – 400.0°C
	K : 10	0.0 – 800.0°C
	K : 29	0.0 – 200.0°C
	K : 37	0.0 – 600.0°C
	K : 38	-199.9 – 800.0°C
	K : A1	0 – 800°F
	K : A2	0 – 1600°F
	K : A3	0 – 2502°F
K : A9	20 – 70°F	
K : A4	0.0 – 800.0°F	
K : B2	-199.9 – 999.9°F	
J (JIS/IEC)	J : 01	0 – 200°C
	J : 02	0 – 400°C
	J : 03	0 – 600°C
	J : 04	0 – 800°C
	J : 05	0 – 1000°C
	J : 06	0 – 1200°C
	J : 10	0 – 450°C
	J : 07	-199.9 – 300.0°C
	J : 08	0.0 – 400.0°C
	J : 09	0.0 – 800.0°C
	J : 22	0.0 – 200.0°C
	J : 23	0.0 – 600.0°C
	J : 30	-199.9 – 600.0°C
	J : A1	0 – 800°F
	J : A2	0 – 1600°F
	J : A3	0 – 2192°F
	J : A6	0 – 400°F
	J : B6	0.0 – 800.0°F
	J : A9	-199.9 – 999.9°F
	R (JIS/IEC)	R : 01
R : 02		0 – 1769°C
R : 04		0 – 1350°C
R : A1		0 – 3200°F
R : A2		0 – 3216°F

Input	Code	Range	
S (JIS/IEC)	S : 01	0 – 1600°C	
	S : 02	0 – 1769°C	
	S : A1	0 – 3200°F	
	S : A2	0 – 3216°F	
B (JIS/IEC)	B : 01	400 – 1800°C	
	B : 02	0 – 1820°C	
	B : A1	800 – 3200°F	
	B : A2	0 – 3308°F	
E (JIS/IEC)	E : 01	0 – 800°C	
	E : 02	0 – 1000°C	
	E : A1	0 – 1600°F	
	E : A2	0 – 1832°F	
N (JIS/IEC)	N : 01	0 – 1200°C	
	N : 02	0 – 1300°C	
	N : 06	0.0 – 800.0°C	
	N : A1	0 – 2300°F	
	N : A2	0 – 2372°F	
	N : A5	0.0 – 999.9°F	
	T (JIS/IEC)	T : 01	-199.9 – 400.0°C
		T : 02	-199.9 – 100.0°C
		T : 03	-100.0 – 200.0°C
		T : 04	0.0 – 350.0°C
T : A1		-199.9 – 752.0°F	
W5Re/W26Re (ASTM)	T : A2	-100.0 – 200.0°F	
	T : A3	-100.0 – 400.0°F	
	T : A4	0.0 – 450.0°F	
	T : A5	0.0 – 752.0°F	
	W : 01	0 – 2000°C	
W : 02	0 – 2320°C		
PLII (NBS)	W : A1	0 – 4000°F	
	A : 01	0 – 1300°C	
	A : 02	0 – 1390°C	
	A : 03	0 – 1200°C	
	A : A1	0 – 2400°F	
U (DIN)	A : A2	0 – 2534°F	
	U : 01	-199.9 – 600.0°C	
	U : 02	-199.9 – 100.0°C	
	U : 03	0.0 – 400.0°C	
	U : A1	-199.9 – 999.9°F	
	U : A2	-100.0 – 200.0°F	
L (DIN)	U : A3	0.0 – 999.9°F	
	L : 01	0 – 400°C	
	L : 02	0 – 800°C	
	L : A1	0 – 800°F	
L : A2	0 – 1600°F		

RTD input (Field-programmable)

Input	Code	Range
Pt100 (JIS/IEC)	D : 01	-199.9 – 649.0°C
	D : 02	-199.9 – 200.0°C
	D : 03	-100.0 – 50.0°C
	D : 04	-100.0 – 100.0°C
	D : 05	-100.0 – 200.0°C
	D : 06	0.0 – 50.0°C
	D : 07	0.0 – 100.0°C
	D : 08	0.0 – 200.0°C
	D : 09	0.0 – 300.0°C
	D : 10	0.0 – 500.0°C
	D : A1	-199.9 – 999.9°F
	D : A2	-199.9 – 400.0°F
	D : A3	-199.9 – 200.0°F
	D : A4	-100.0 – 100.0°F
	D : A5	-100.0 – 300.0°F
D : A6	0.0 – 100.0°F	
D : A7	0.0 – 200.0°F	
D : A8	0.0 – 400.0°F	
D : A9	0.0 – 500.0°F	
JPt100 (JIS)	P : 01	-199.9 – 649.0°C
	P : 02	-199.9 – 200.0°C
	P : 03	-100.0 – 50.0°C
	P : 04	-100.0 – 100.0°C
	P : 05	-100.0 – 200.0°C
	P : 06	0.0 – 50.0°C
	P : 07	0.0 – 100.0°C
	P : 08	0.0 – 200.0°C
	P : 09	0.0 – 300.0°C
	P : 10	0.0 – 500.0°C

Voltage/Current DC input ³(Field-programmable)

Input	Code	Range
0 to 5V	4 : 01	0.0 – 100.0%
0 to 10V	5 : 01	0.0 – 100.0%
1 to 5V	6 : 01	0.0 – 100.0%
0 to 20mA	7 : 01	0.0 – 100.0%
4 to 20mA	8 : 01	0.0 – 100.0%

¹ Type R,S and B input : Accuracy is not guaranteed less than 399°C (751°F).

² Type T and U input : Accuracy is not guaranteed less than -100.0°C (-148.0°F).

³ DC current input : A 250 Ω resistor is externally connected at the input terminals.

Model and Suffix Code

Alarm Code Table

A	Deviation High	B	Deviation Low	C	Deviation High/Low	D	Deviation Band
E	Deviation High with Hold	F	Deviation Low with Hold	G	Deviation High/Low with Hold	H	Process High
J	Process Low	K	Process High with Hold	L	Process Low with Hold	R	Loop break alarm ¹
V	Set value High	W	Set value Low				













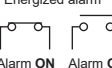



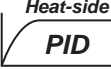

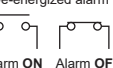

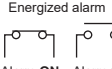
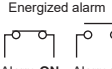

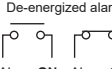
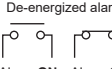

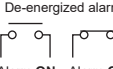
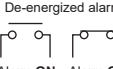

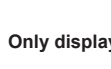

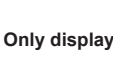
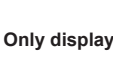

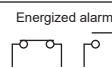
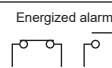
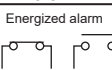
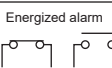
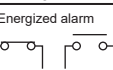
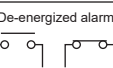
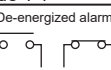
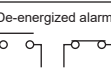
¹ Loop break alarm is not available with Heat/Cool PID control type. Loop break alarm is not available with Alarm 2.

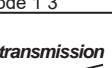
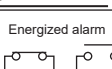
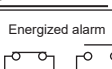
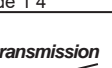
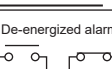
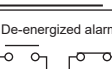
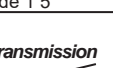
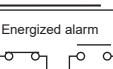
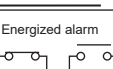
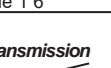
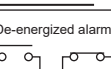
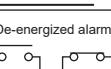
Output Allocation Code Table

Code	Specifications		
	Control methods	Output 1	Output 2
0 3	PID control + Alarm 1	Control output	Alarm 1 output (De-energized)
0 4	PID control + Alarm 1, 2	Control output	AND logic output of Alarm 1 and Alarm 2 (Energized)
0 5	PID control + Alarm 1, 2	Control output	OR logic output of Alarm 1 and Alarm 2 (De-energized)
0 6	PID control + Alarm 1, 2	Control output	AND logic output of Alarm 1 and Alarm 2 (De-energized)
0 7	PID control + Alarm 1, 2 or only Alarm 1 ¹	Control output	No output
0 8	PID control + Alarm 1, 2	1 Control output	Only Alarm 1 output (Energized)
0 9	Alarm 1 + Alarm 2	2 Alarm 1 output (Energized)	Alarm 2 output (Energized)
1 0	Alarm 1 + Alarm 2	2 Alarm 1 output (Energized)	Alarm 2 output (De-energized)
1 1	Alarm 1 + Alarm 2	2 Alarm 1 output (De-energized)	Alarm 2 output (De-energized)
1 2	Retransmission + PID control	Retransmission output	Control output
1 3	Retransmission + Alarm 1, 2	Retransmission output	OR logic output of Alarm 1 and Alarm 2 (Energized)
1 4	Retransmission + Alarm 1, 2	Retransmission output	OR logic output of Alarm 1 and Alarm 2 (De-energized)
1 5	Retransmission + Alarm 1, 2	Retransmission output	AND logic output of Alarm 1 and Alarm 2 (Energized)
1 6	Retransmission + Alarm 1, 2	Retransmission output	AND logic output of Alarm 1 and Alarm 2 (De-energized)
1 7	Retransmission + Alarm 1	Retransmission output	Alarm 1 output (Energized)
1 8	Retransmission + Alarm 1	Retransmission output	Alarm 1 output (De-energized)
1 9	Heat-Cool PID control	Cool output (DC current output)	Heat output (Relay contact or Voltage pulse output)

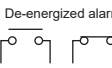
¹ The alarm monitor can only be confirmed by front LCD display or serial communication.

² Specify control action F to use both outputs as alarms.

<p>Standard</p> <p>Output 1</p> <p>OUT1 </p> <p>Output 2</p> <p>No alarm</p>	<p>Standard</p> <p>Output 1</p> <p>OUT1 </p> <p>Output 2</p> <p>Energized alarm</p> <p>ALM1  Alarm ON Alarm OFF</p>	<p>Standard</p> <p>Output 1</p> <p>OUT1 </p> <p>Output 2</p> <p>Energized alarm</p> <p>ALM1  Alarm ON Alarm OFF</p> <p>ALM2  Alarm ON Alarm OFF</p> <p>"OR" logic</p>	<p>Standard</p> <p>Output 1</p> <p>OUT1 </p> <p>Output 2</p> <p>Cool-side</p> <p>OUT2 </p>	<p>Code 0 3</p> <p>Output 1</p> <p>OUT1 </p> <p>Output 2</p> <p>De-energized alarm</p> <p>ALM1  Alarm ON Alarm OFF</p>
<p>Code 0 4</p> <p>Output 1</p> <p>OUT1 </p> <p>Output 2</p> <p>Energized alarm</p> <p>ALM1  Alarm ON Alarm OFF</p> <p>ALM2  Alarm ON Alarm OFF</p> <p>"AND" logic</p>	<p>Code 0 5</p> <p>Output 1</p> <p>OUT1 </p> <p>Output 2</p> <p>De-energized alarm</p> <p>ALM1  Alarm ON Alarm OFF</p> <p>ALM2  Alarm ON Alarm OFF</p> <p>"OR" logic</p>	<p>Code 0 6</p> <p>Output 1</p> <p>OUT1 </p> <p>Output 2</p> <p>De-energized alarm</p> <p>ALM1  Alarm ON Alarm OFF</p> <p>ALM2  Alarm ON Alarm OFF</p> <p>"AND" logic</p>	<p>Code 0 7</p> <p>Output 1</p> <p>OUT1 </p> <p>Output 2</p> <p>Only display</p> <p>ALM1  Alarm ON Alarm OFF</p>	<p>Code 0 7</p> <p>Output 1</p> <p>OUT1 </p> <p>Output 2</p> <p>Only display</p> <p>ALM1  Alarm ON Alarm OFF</p> <p>ALM2  Alarm ON Alarm OFF</p>
<p>Code 0 8</p> <p>Output 1</p> <p>OUT1 </p> <p>Output 2</p> <p>Energized alarm</p> <p>ALM1  Alarm ON Alarm OFF</p> <p>ALM2  Alarm ON Alarm OFF</p> <p>Output alarm 1 only</p>	<p>Code 0 9</p> <p>Output 1</p> <p>ALM1  Alarm ON Alarm OFF</p> <p>Output 2</p> <p>Energized alarm</p> <p>ALM2  Alarm ON Alarm OFF</p>	<p>Code 1 0</p> <p>Output 1</p> <p>ALM1  Alarm ON Alarm OFF</p> <p>Output 2</p> <p>De-energized alarm</p> <p>ALM2  Alarm ON Alarm OFF</p>	<p>Code 1 1</p> <p>Output 1</p> <p>ALM1  Alarm ON Alarm OFF</p> <p>Output 2</p> <p>De-energized alarm</p> <p>ALM2  Alarm ON Alarm OFF</p>	<p>Code 1 2</p> <p>Output 1</p> <p>Retransmission </p> <p>Output 2</p> <p>OUT2 </p>
<p>Code 1 3</p> <p>Output 1</p> <p>Retransmission </p> <p>Output 2</p> <p>Energized alarm</p> <p>ALM1  Alarm ON Alarm OFF</p> <p>ALM2  Alarm ON Alarm OFF</p> <p>"OR" logic</p>	<p>Code 1 4</p> <p>Output 1</p> <p>Retransmission </p> <p>Output 2</p> <p>De-energized alarm</p> <p>ALM1  Alarm ON Alarm OFF</p> <p>ALM2  Alarm ON Alarm OFF</p> <p>"OR" logic</p>	<p>Code 1 5</p> <p>Output 1</p> <p>Retransmission </p> <p>Output 2</p> <p>Energized alarm</p> <p>ALM1  Alarm ON Alarm OFF</p> <p>ALM2  Alarm ON Alarm OFF</p> <p>"AND" logic</p>	<p>Code 1 6</p> <p>Output 1</p> <p>Retransmission </p> <p>Output 2</p> <p>De-energized alarm</p> <p>ALM1  Alarm ON Alarm OFF</p> <p>ALM2  Alarm ON Alarm OFF</p> <p>"AND" logic</p>	<p>Code 1 7</p> <p>Output 1</p> <p>Retransmission </p> <p>Output 2</p> <p>Energized alarm</p> <p>ALM1  Alarm ON Alarm OFF</p>
<p>Code 1 8</p> <p>Output 1</p> <p>Retransmission </p> <p>Output 2</p> <p>De-energized alarm</p> <p>ALM1  Alarm ON Alarm OFF</p>	<p>Code 1 9</p> <p>Output 1</p> <p>OUT1 </p> <p>Output 2</p> <p>OUT2 </p>	<p>Note: Relay contact output : 250V AC 2A (resistive load), Form A contact</p> <p></p> <p>Power supply OFF : Open</p>		

Accessories

Name	Model code
Shunt resistor for DC current input	KD100-55
Terminal cover	KSA200-56A

Temperature Controller SA200

External Dimensions and Rear Terminals

Units : mm

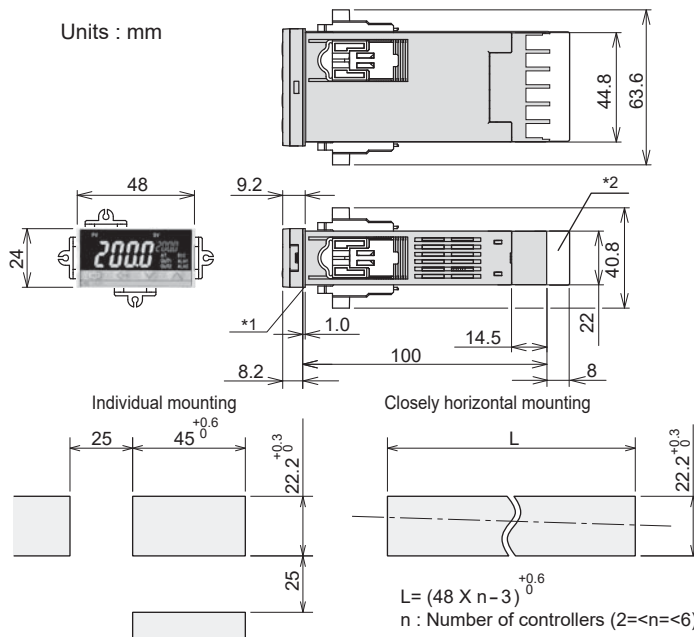

*1 For Waterproof/Dustproof models, a rubber gasket is added.

*2 Terminal cover is optional.

For mounting of the SA200, panel thickness must be between 1-10 mm. When mounting multiple SA200s close together, the panel strength should be checked to ensure proper support.

Two mounting brackets will be furnished for installation of the instrument at either the top and bottom or sides.

Close vertically and horizontally mounted instruments cannot be combined in one installation.

Warning

If the SA200s have waterproof/dustproof option, protection may be compromised by close mounting. Close vertical mounting is not available when a shunt resistor for current input is used.

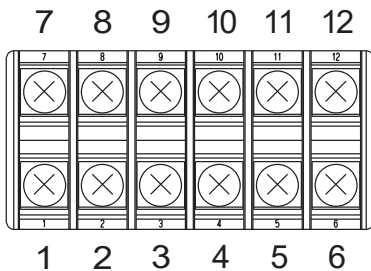

No.	1	2	3	4	5	6
Contents						
	Power supply		Output 1	Output 2		

No.	7	8	9	10	11	12
Contents						
	Measurement Input			Communications / Contact inputs		

Note :

- For terminal connection, use lug that is 5.8 mm wide or less.

*A 250Ω resistor is externally connected at the input terminals.

e-con type Controller

SA220



(easy and economy connector)



Safety Warning

- Before operating this product, read the instruction manual carefully to avoid incorrect operation.
- This product is intended for use with industrial machines, test and measuring equipment. It is not designed for use with medical equipment.
- If it is possible that an accident may occur as a result of the failure of the product or some other abnormality, an appropriate independent protection device must be installed.
- When installing this product, avoid the following:
Direct exposure to sunlight. Direct contact with water.
Corrosive environments. Hazardous areas containing explosive or flammable gases.
Vibration or shock.
Areas subject to electrical noise caused by inductive interference, static electricity or magnetic fields.

Caution for counterfeit products

Please be cautious of purchasing counterfeit products. Please understand that we shall not be liable for any damage and/or accident caused by the use of counterfeit products.

RKC® **RKC INSTRUMENT INC.**
(RIKA KOGYO CO.,LTD)

HEAD OFFICE : 16-6, KUGAHARA 5 CHOME OHTA-KU TOKYO 146-8515 JAPAN
PHONE : 03-3751-9799 (+81 3 3751 9799)
Email : info@rkinst.co.jp
FAX : 03-3751-8585 (+81 3 3751 8585)
https://www.rkinst.com/