

THW-A



General Description

Three phase power controller has an LED display to show set values and input signals and front keys for easy setting and monitoring. Loaded with versatile standard functions, the THW operates at 100 up to 240V AC and automatically selects power supply frequency 50 or 60Hz.

The THW three phase power control unit can be used with control modes selectable from constant voltage, constant current and constant power, it can be used with such heaters as noble metals (Platinum and molybdenum), super Kanthal, and SiC (Silicon Carbide) that have changing resistance in accordance with temperature changes.

Features

- ☆ Control type selection (Phase-angle/continuous zero-cross/zero-cross)
- ☆ Ramp-up, Ramp-down
- ☆ Gradient setting
- ☆ Output Limiter High and Low

- ☆ Base-up Setting (output bias)
- ☆ Output mode selection (proportional electric power/voltage/phase angle)
- ☆ Digital input for Auto/manual

Three Types of Control Mode (Selectable)

● Phase control

The wave form of the load power is switched at a desired phase angle q to provide smooth control.



● Zero-cross control (Continuous proportion)

Power is switched on and off when the supply voltage is at 0V. This system suppresses high frequency noise inherent to phase control.



● Zero-cross control (Input synchronization system)

Supply voltage is switched on and off according to the voltage pulse and contact signals from a controller.



Constant current control (For phase control only)

This function maintains the output current constant when a load or a power supply fluctuates. It makes the THW Series suitable for heaters of which resistance greatly changes by temperature change, such as Platinum, Molybdenum, Tungsten, and Kanthal heaters.

Constant current control characteristic diagram

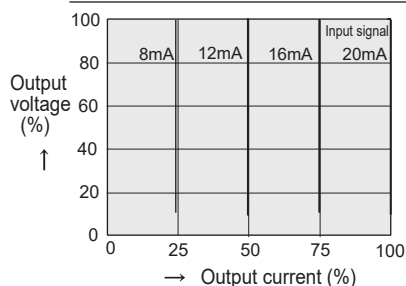

Constant power control (For phase control only)

This function controls the output to make its effective value power proportional to the input. It makes the THW Series suitable for heaters of which resistance gradually increases by temperature or time, such as silicon carbide type heater.

This function controls its effective value power at 50% of the rating shown in the diagram below.

• From the diagram below, constant power control is expressed as a curve obtained from a line between two points which is a 50% of the rating of the unit; a point at 100% voltage x 50% current and a point at 50% voltage x 100% current.

Constant power control characteristic diagram

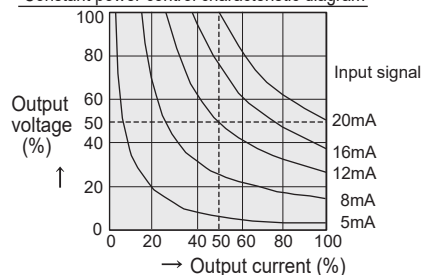

Load current limiter (For phase control only)

This function limits the load current value to the heater. The setting range is 30 to 100% of the rated current.

(Note) If the load has a large inrush current, use soft-start function along with this function to suppress the inrush current. This function alone can not prevent the inrush current.

Current limiter characteristic diagram

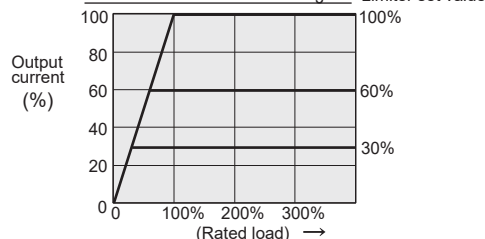

Three Phase Power Controller THW-A Series

Features

Gradient Setting

The relation between the setting input and the output voltage can be set. Gradient setting is possible via front keys or an external setter. Control characteristics may vary with the setting as follows.

1. Auto setting input X Internal gradient setting X External gradient setting
2. Auto setting input X Internal gradient setting
3. Manual setting X Internal gradient setting X External gradient setting

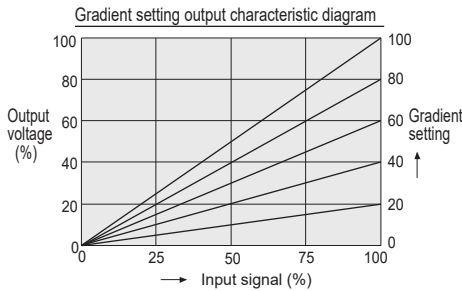

Ramp Function (Soft-start & Soft-down)

Even if setting input changes abruptly, output changes slowly to suppress inrush current. Ramp-up (Start-up) and ramp down (Start-Down) time can be set in the range of 0.1 to 99.9 sec via front keys.

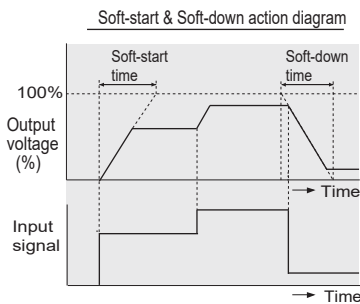

Base-up setting (Output bias)

When the setting input is zero, the output can be set via front keys.

(Base-up setting is valid when output limiter low is set to 0.0)

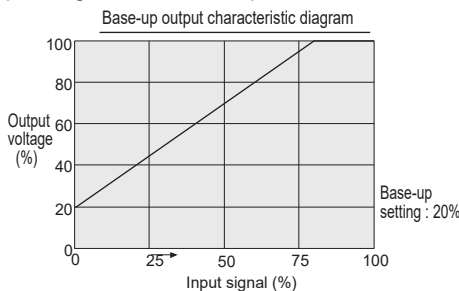

Output limiter (High & Low)

Highest and lowest output values can be set via front keys.

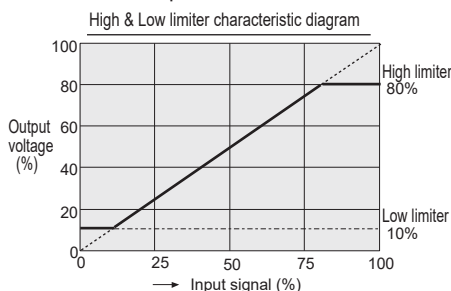

Output modes

When phase control is selected for linear load (R: resistor), output mode can be selected from Proportional phase angle to input, proportional voltage to input, and proportional square voltage (electric power) to input.

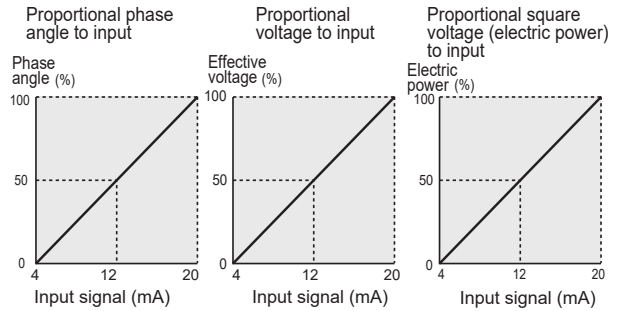

Output limiter High at start-up

This function limits the highest output for the period of a preset time after power-ON. It makes the THV-A1 Series suitable for heaters which cause rush current flow, such as Halogen lamp, Tungsten, Platinum, and Molybdenum heaters.

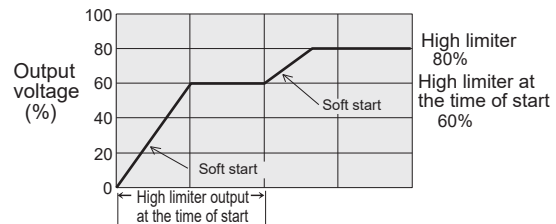

Heater break alarm

This function measures load current and compares it with a heater break alarm set value. Alarm will be activated if the load current goes into alarm ranges. Maximum two alarm set points can be set for the heater break alarm, which could be used for heater-deterioration alarm and heater-break alarm.

(Note) For phase control, heater break alarm does not work when the load current is less than 15% of maximum load current.

Over-current alarm

The alarm goes on when the load current exceeds 120% of the rated current.

Fuse break alarm

The alarm goes on when a fast blown fuse is blown. The fuse with alarm output function must be used to use this function.

Event input and alarm function

The contact input can be configured to Run/Stop, Auto/Manual or alarm interlock reset. The alarm types are reverse phase detection, power frequency abnormal, and FAIL. Alarm output will go on, when any of them goes in alarm status. Optional heater break alarm and over-current alarm can be also configured as an output (alarm logic selection).

Specifications

Maximum Load Current

20AAC, 30AAC, 45AAC, 60AAC, 80AAC, 100AAC

Control Method

Phase control, Zero-cross control (Selectable)

Applicable Load

Phase control : Linearity (R:Resistor) load, Control of primary side of a transformer (magnetic field density 8,000 gauss or less)

Zero-cross control : Linearity (R:Resistor) load

Input Signal

Group 1 (Field-programmable within Group)

Current input 4 to 20mA DC (Input impedance : 100Ω)

Current input 0 to 20mA DC (Input impedance : 100Ω)

Voltage input 0 to 5V DC (Input impedance : 30kΩ)

Voltage input 1 to 5V DC (Input impedance : 30kΩ)

Voltage pulse input 0/12V DC (Input impedance : 30kΩ)

Non-voltage contact input

Group 2 (Field-programmable within Group)

Voltage input 0 to 10V DC (Input impedance : 68kΩ)

Voltage pulse input 0/12V DC (Input impedance : 68kΩ)

Voltage pulse input 0/24V DC (Input impedance : 68kΩ)

Non-voltage contact input

Output mode

When phase control is selected for linearity load (R: resistor), output mode can be selected from Proportional phase angle to input, proportional voltage to input, and proportional square voltage (electric power) to input.)

Minimum Load Current

1A

Output Voltage Range

0 to 98% of rated voltage

Power Supply Voltage

a) 90 to 264V AC (Including power supply voltage variation)

Rating : 200 to 240V AC

b) 360 to 484V (Including power supply voltage variation)

Rating : 400 to 440V AC

• Power supply voltage for control circuit voltage is 180 to 264VAC. A step-down transformer is supplied with the main unit (Including power supply voltage variation)

Power Frequency

50/60Hz (Automatic discriminating)

Allowable Power Frequency Variation

50Hz±1Hz, 60Hz±1Hz,(Performance guarantee range)

45 to 54.9Hz (50Hz), 55 to 64.9Hz (60Hz) (Operating guarantee range)

Allowable Ambient Temperature

Performance guarantee range: 0 to +40°C

Operating guarantee range: -15 to +55°C

Operating ambient humidity

5 to 95%RH (Non-condensing)

Absolute humidity : MAX.W.C 29.3g/m³ dry air at 101.3kPa

Cooling method

Natural convection

Dielectric voltage

Between main circuit terminals, power terminals and heat sink 2000V AC for one minute.

Insulation resistance

Between main circuit terminals, power terminals and heat sink 20MΩ or more (500V DC)

Mounting Method

Vertical mounting

Weight

Approx. 5.8kg (20 to 60A, 200V), Approx. 10.3kg (20 to 60A, 400V),

Approx. 13.6kg (80A,100A, 200V and 400V)

Power consumption

Less than 17VA (200V type), Less than 21VA (200V AC type)

Self-diagnostic function

Check item

Board check, EEPROM check, Adjustment data check, Set value range check

Action at abnormality :

FAIL lamp ON, Thyristor output OFF

(The alarm output can be output from the alarm terminals.)

Output Setting Range

Gradient setting : 0.0 to 100.0% [Front key],
0 to 100% [External setting unit]
Output limiter (High) : 0.0 to 100.0% [Front key]
Output limiter (Low) : 0.0 to 100.0% [Front key]
Output limiter at start-up (High) : 0.0 to 100.0% [Front key]
Output limiter time at start-up (Low) : 0.0 to 600.0 sec [Front key]
Base-up setting (Output bias) : -10.0 to 100.0% [Front key]
Manual setting : 0.0 to 100% [Front key]
0 to 100% [External setting unit]

Standard functions

- Digital input (DI) : 3 points, Non-voltage contact input
RUN/STOP, Auto/Manual, Alarm interlock reset
- Gradient setting (External setting unit is optional)
- Soft-up/Soft-down : 0.0 to 99.9sec
- Alarm output : 2 points
Open collector output, 24V DC, Max.100mA
Energized/De-energized is selectable.
Output logic selection function
 1. Heater break alarm *1
 2. Thyristor break alarm *1
 3. OR logic of heater break alarm *1 and thyristor break alarm *1
 4. OR logic of FAIL, power frequency abnormal, reverse phase detection, over-current alarm *1, fuse break down *1
 5. OR logic of all alarm
 *1: Optional alarm type
- ON/OFF control (External setting units are optional)

Option function

- Heater break alarm
Current measuring accuracy : ±2A (20A, 30A type)
±10% of Max. load current
(45A, 60A, 80A, 100A type)
Number of alarm delay times : 0 to 99 times
- Load current limiter
Setting range : 0 to 22A (20A type), 0 to 33A (30A type)
0 to 50A (45A type), 0 to 66A (60A type)
0 to 88A (80A type), 0 to 110A (100A type)

• Table of Stability

Function	Operating condition	Stability
Constant voltage	Power supply variation : Within ±10% Load variation : 2 times	Within ±2% of full scale
Constant current	Power supply variation : Within ±10% Load variation : 2 times	Within ±2% of full scale
Constant power variation	Power supply variation: Within ±10% Load variation : 2 times	Within ±4% of full scale

• Table of internal calorific value

Rated load current (A)	20	30	45	60	80	100
Internal calorific value (W)	82	118	172	226	298	370

• Temperature characteristics of load current

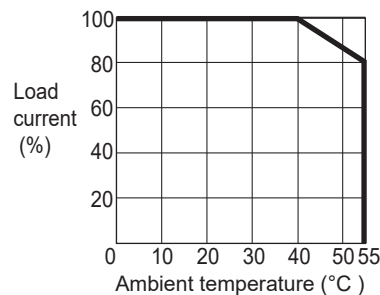

Three Phase Power Controller THW-A Series

Model and Suffix Code

Specifications	Model and Suffix Code										
Type	Three Phase Thyristor Unit			THW-A			<input type="checkbox"/> PZ	<input type="checkbox"/> -	<input type="checkbox"/> *	<input type="checkbox"/> N	<input type="checkbox"/>
Power supply *1	200 to 240V AC 400 to 440V AC			1	4						
Control method	Phase control/Zero-cross control (programmable, default: phase control)			PZ							
Max. load current	20A AC 30A AC 45A AC 60A AC 80A AC 100A AC							020			
Input signal *2	0 to 5V DC 0 to 10V DC 1 to 5V DC 0 to 20mA DC 4 to 20mA DC									4	
Output mode	Standard (Proportional phase angle • Proportional voltage • Proportional square voltage) Standard + Constant voltage control Standard + Constant voltage control (with heater break alarm and load current limiter) Standard + Constant current control (with heater break alarm and load current limiter) Standard + Constant power control (with heater break alarm and load current limiter)									5	
Fast-blow fuse *3	No fast-blow fuse With fast-blow fuse (No fuse break alarm output) With fast-blow fuse (With fuse break alarm output)									6	
Optional function	No optional function									7	
Accessories *4,*5,*6	Setter (Volume, knob, Scale plate) 1 unit + Connector (Plug) Setter (Volume, knob, Scale plate) 2 units + Connector (Plug) Connector (Plug)									8	
											N
											6
											V
											E
											W
											N
											F
											S
											N
											-1
											-2
											-9

*1 : When 400 to 440VAC is selected as power supply, a step-down transformer for the THW unit power supply is supplied as standard.

*2 : Input signal is programmable within group.

Group 1 | 0 to 20mA DC | 4 to 20mA DC | 0 to 5V DC | 1 to 5V DC | Voltage pulse 0/12V DC | Non-voltage contact

Group 2 | 0 to 10V DC | Voltage pulse 0/12V DC | Voltage pulse 0/24V DC | Non-voltage contact

*3: When optional heater break alarm and load current limiter are specified, over-current alarm and thyristor break alarm are also supplied.

*4: When contact input or/and alarm output is required, specify the connector as an accessory.

*5: Setters are for external gradient setting, external manual setting, and external high/low setting for on/off control. Use two units of setter in the following cases;

- When external gradient setting and external manual setting are required.
- High/low setting for on/off control is used.

*6: It is possible to specify more than one accessories by adding suffix code at the end. (Example: -1-9)

Accessories

- Gradient setter, Manual setter, High/Low setter : THV1P-S01

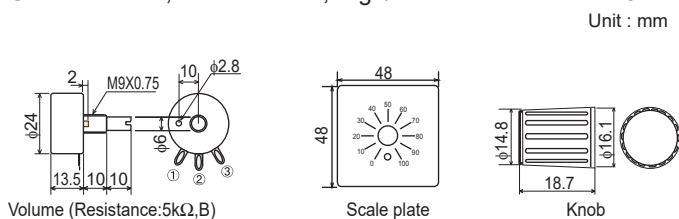

- Step-down transformer : THVP-T01

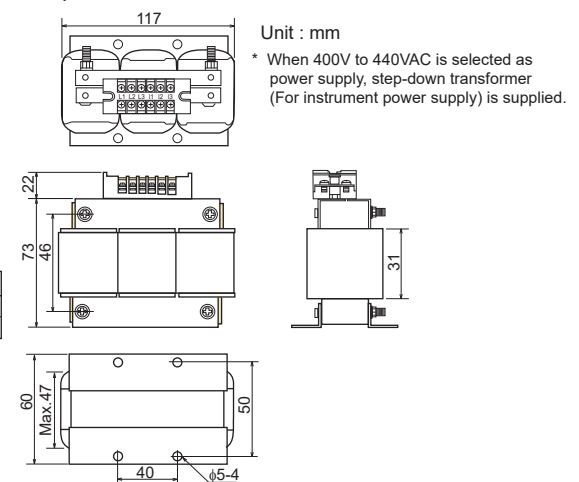

Model code

Name	Model Code	Name	Model Code
Setter	THV1P-S01	Terminal cover (For main circuit terminal)	20A, 30A, 45A, 60A 80A, 100A
Connector (plug)	THWP-C01		THWP-A11
Voltage down transformer	THWP-T01		THWP-A12

Name	Model Code	Name	Model Code
Fast-blow fuse (Unit : 1 piece)	200V	20A	THWP-F20
		30A	THWP-F30
		45A/60A	THWP-F40
	400V	80A	THWP-F80
		100A	THWP-FA0
		20A	THWP-F22
Fast-blow fuse with fuse break (Unit : 1 piece)	200V	20A	THWP-F21
		30A	THWP-F31
		45A/60A	THWP-F41
	400V	80A	THWP-F81
		100A	THWP-FA1
		20A	THWP-F23
	30A	THWP-F33	
	45A/60A	THWP-F43	
	80A	THWP-F83	
100A	THWP-FA3		

* When 400V to 440VAC is selected as power supply, step-down transformer (For instrument power supply) is supplied.

Three Phase Power Controller THW-A Series

External Dimensions

○ 200V : 20A, 30A, 45A, 60A

○ 400V : 20A, 30A, 45A, 60A

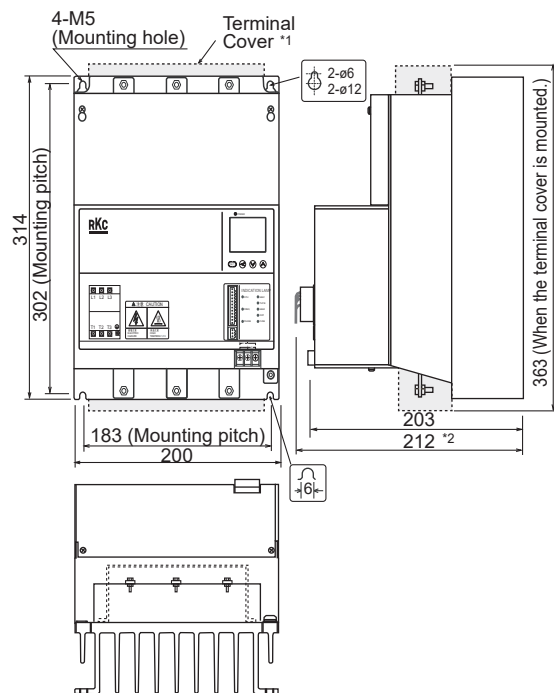
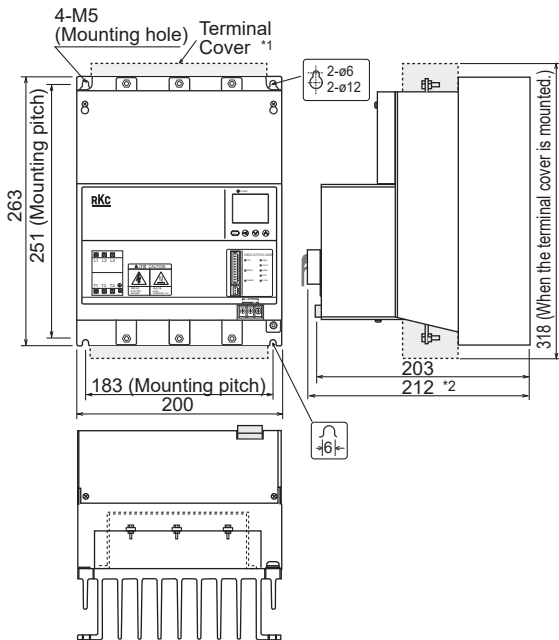

○ 200V : 80A, 100A
400V : 80A, 100A

• Install the instrument as illustrated in the drawing to increase the cooling effect.

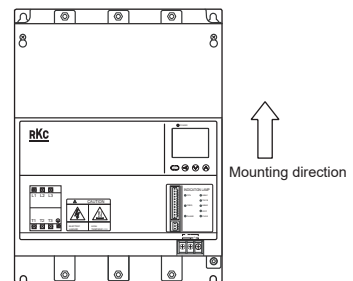
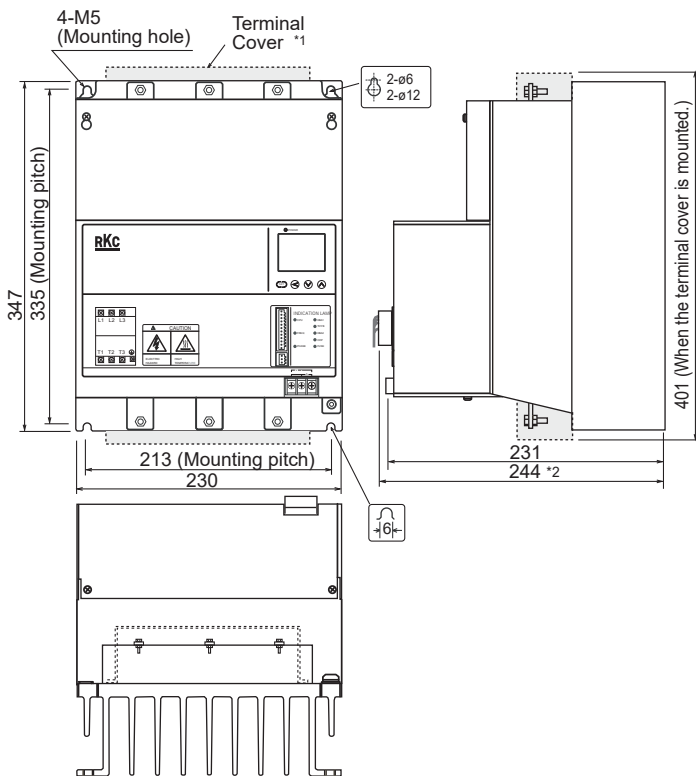

• When multiple units are installed, space between units must satisfy the rules shown in the drawing below.

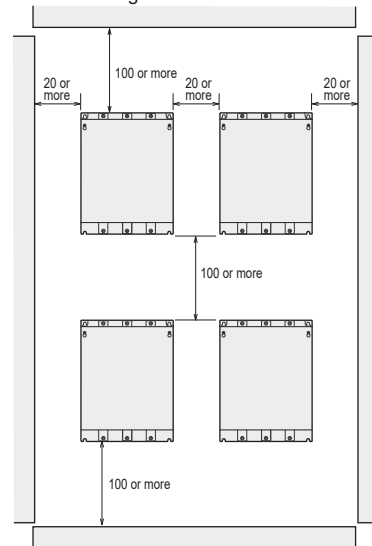

*1 The terminal cover is a standard attachment.

*2 Length includes that of an optional connector, but space for wiring to connector is not included.

CAUTION

- Prevent metal fragments or load wire scraps from falling inside instrument to avoid electric shock, fire or malfunction.
- All wiring must be completed before power is turned on to prevent electric shock, fire or incorrect action.

Three Phase Power Controller THW-A Series

External Wiring

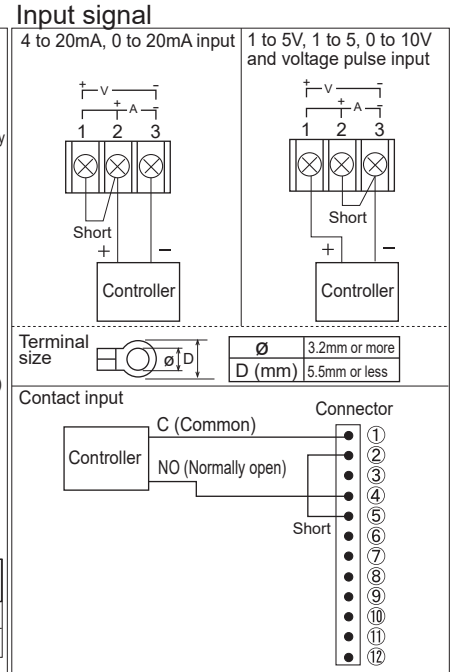
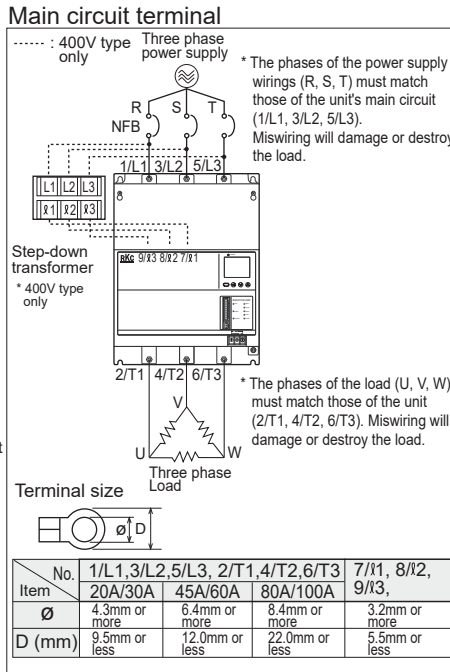
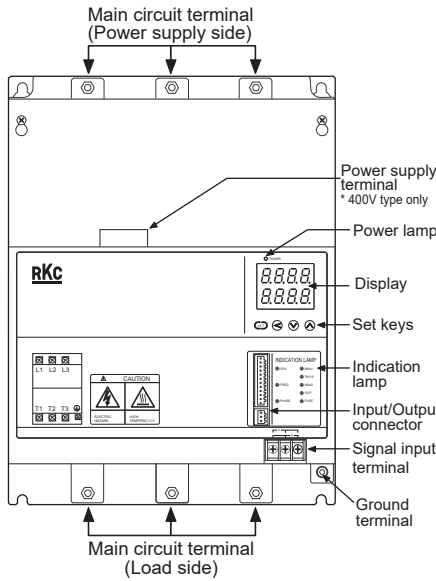

Indication Lamp

INDICATION LAMP	Lamp	Contents
● FAIL	● HBA1	FAIL (Self-diagnostic abnormality)
● THY_B	● THY_B	Power frequency abnormality
● FREQ	● HBA2	PHASE Reverse phase detection
● PHASE	● OCR	HBA1 Heater break alarm SV1
	● FUUSE	THY_B Thyristor break alarm
		HBA2 Heater break alarm SV2
		OCR Over current alarm
		FUSE Fuse break alarm

* Up to two alarm set points can be set for the heater break alarm.

* Fuse break alarm lamp is available when a fast blow fuse with fuse break alarm output is used.

Connector

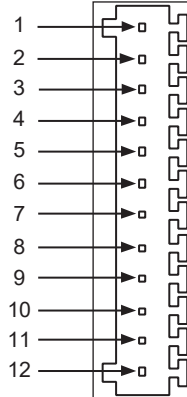

Pin No.	Contents
1	+5V output
2	0V (GND)
3	Gradient setting input (0 to 5V input by gradient setter)
4	Manual setting input (0 to 5V input by manual setter)
5	External contact input (Auto/manual setting selection) Pin No.2 - No.5, Open : Auto setting mode Pin No.2 - No.5, Close : Manual setting mode.
6	External contact input (RUN/STOP selection) Pin No.2 - No.6, Open : Stop mode Pin No.2 - No.6, Close : Run mode.
7	External contact input (Alarm interlock reset) Pin No.2 - No.6, Close : Alarm interlock reset
8	Unused
9	DC24V (+)
10	Open collector output (+) : Alarm 1 output
11	Open collector output (+) : Alarm 2 output
12	0V

• Auto setting (With gradient setter)

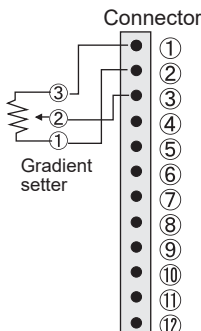

• Auto/Manual setting selection (With gradient setter)

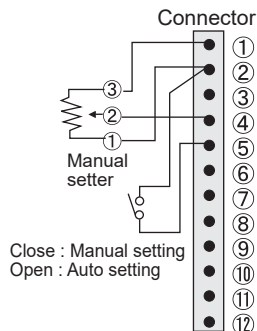

• Auto/Manual setting selection (With manual setter)

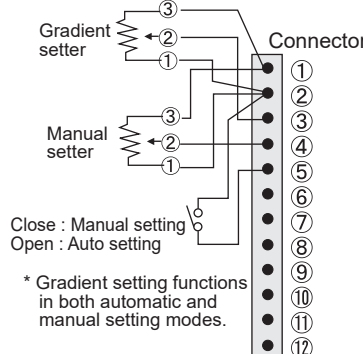

• Manual setting (With manual setter)

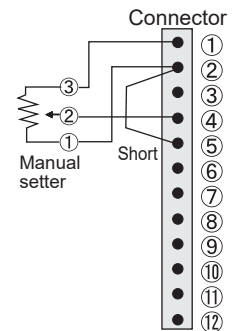

• External contact input

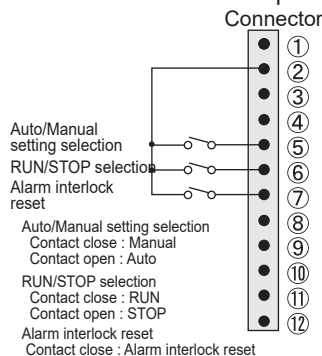

• ON/OFF control

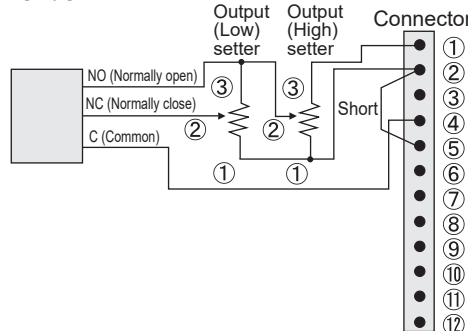

• Alarm output

